

On the counting of $O(N)$ tensor invariants

REMI C. AVOHOU, JOSEPH BEN GELOUN, AND NICOLAS DUB

$O(N)$ invariants are the observables of real tensor models. We use regular colored graphs to represent these invariants, the valence of the vertices of the graphs relates to the tensor rank. We enumerate $O(N)$ invariants as d -regular graphs, using permutation group techniques. We also list their generating functions and give (software) algorithms computing their number at an arbitrary rank and an arbitrary number of vertices. As an interesting property, we reveal that the algebraic structure which organizes these invariants differs from that of the unitary invariants. The underlying topological field theory formulation of the rank d counting shows that it corresponds to counting of coverings of the $d - 1$ cylinders sharing the same boundary circle and with d defects. At fixed rank and fixed number of vertices, an associative semi-simple algebra with dimension the number of invariants naturally emerges from the formulation. Using the representation theory of the symmetric group, we enlighten a few crucial facts: the enumeration of $O(N)$ invariants gives a sum of constrained Kronecker coefficients; there is a representation theoretic orthogonal base of the algebra that reflects its dimension; normal ordered 2-pt correlators of the Gaussian models evaluate using permutation group language, and further, via representation theory, these functions provide other representation theoretic orthogonal bases of the algebra.

1	Introduction	822
2	$O(N)$ invariants and real tensor models	826
3	Counting $O(N)$ invariants	827
4	Double coset algebra	837
5	Correlators	849

6	On $Sp(2N)$ tensor invariants	855
7	Conclusion	857
Appendix A	Symmetric group and its representation theory	859
Appendix B	Codes	869
References		874

1. Introduction

Since their inception [1–3], random tensor models offer a framework for studying random discrete geometries as they aim at extending the success of matrix models [4] in describing 2D quantum gravity, to higher dimensions. The main goal of this approach is to devise a transition of discrete geometries to continuum geometries in any dimension. It is however only recently that random tensor models have witnessed significant progress [5] with the advent of a new large N expansion generalizing ‘t Hooft genus expansion [6] for higher dimensional pseudo-manifolds. The existence of a large N expansion for tensors [7] naturally unveiled several analytical results, among which the discovery of their critical behavior (branched polymers [8, 9]), the universality property of random tensors [10], and the discovery of new families of renormalizable non-local quantum field theories with interesting UV [11–13] and nonperturbative behaviors supporting the discovery of new universality classes for gravity [14–16].

More recently, and quite unexpectedly, tensor models become the center of new attention in condensed matter physics: the dominant contributions of the so-called Sachdev-Ye-Kitaev (SYK) model [17, 18] in the large mode expansion of the disorder match with the large N expansion of a quantum mechanical tensor model without disorder [19]. For its deep connections with black hole physics and AdS/CFT correspondence, the SYK model embodies a vibrant topic of research. The conjunction of tensor and SYK models has incidentally produced a new fast-evolving field on which a growing community is working.

Several, if not all of these studies, heavily rest on the understanding of the combinatorics of Feynman graphs and observables of tensor models. To that extent, the investigations of tensor models have produced a wealth

of results. We will focus on two particular contributions on tensor model graphs that the present work extends.

In [20], the authors worked out the enumeration of the unitary invariants, as observables in complex tensor models. One way of comprehending the theory space of rank d complex tensor models is to specify its set of observables. The latter are merely $U(N)^{\otimes d}$ invariants (at time, we simply call them $U(N)$ or complex tensor invariants). A convenient manner to represent $U(N)$ invariants defines as a canonical mapping to d -regular bipartite colored graphs [21]. Stated in this way, the inventory of tensor invariants formulates by uniquely using permutation groups. One should record that these symmetry group techniques and its representation theory have been developed during the last years [22]–[33]. They turned out to be powerful, flexible and versatile enough to address diverse enumeration problems and bijections from scalar field theory, matrix models, to gauge (QED, 2D and 4D Yang-Mills) and string theories. In physics, for instance, they brighten the half-BPS sector of $\mathcal{N} = 4$ SYM [22]–[27]. Moreover, unforeseen correspondences arise from these studies, for instance, counting Feynman graphs in ϕ^4 scalar field theory relates to string theory on a cylinder or listing Feynman graphs of QED relates to the counting of ribbon graphs [26]. These correspondences emerge from another interface playing a hinge role between enumeration problems: via the Burnside lemma, with each enumeration problem using the symmetric group (and its subgroups), we can associate a Topological Field Theory on a 2-complex (named TFT_2) with gauge group given by the symmetric group (and its subgroups). Such a formulation also unfolds multiple interpretations of the counting formulae with links with the theory of covering spaces in algebraic and complex geometry (see references in [26]).

The reference [20] establishes several enumeration formulae pertaining to observables of complex tensor models. Using the Burnside lemma, one recasts that the enumeration of $U(N)$ invariants into a partition of a permutation lattice gauge field theory, a TFT_2 . It is via this mapping that one elucidates that counting unitary invariants corresponds to counting branched covers of the 2-sphere. Branched covers are well known objects in algebraic and complex geometry [34], in topological string theory, and in dimension 2, they correspond to complex maps [25]. Thus, there is an underlying geometry inherited by tensor models from the TFT_2 formulation that still needs to be understood. There is however a proviso: the counting formulae are valid when the size N of the tensor indices are larger than the number of tensors convoluted. More generally, one should resort to a more careful study [32, 33].

The study of tensor invariants has a follow-up in [35]. Their equivalent classes are viewed as the base elements of a vector space $\mathcal{K}_d(n)$, a subspace of $\mathbb{C}(S_n)^{\otimes d}$, the rank d group algebra of the symmetric group S_n . $\mathcal{K}_d(n)$ shows stability under an associative product, and it is endowed with a non-degenerate pairing. Therefore, at a fixed rank d and fixed number of vertices n , tensor invariants span a semi-simple algebra. (Note that, importantly, other algebraic structures could set up on tensor invariants [36–38]. The above structure is however unique, up to isomorphism.) As a consequence of the Wedderburn-Artin theorem, any semi-simple algebra decomposes as a sum of irreducible matrix subalgebras. The representation theory of the symmetric group sheds more light on the remaining analysis as it enables to reach the Wedderburn-Artin matrix decomposition of the algebra of tensor observables: the dimension of the algebra is a sum of squares of the Kronecker coefficients (these are multiplicity dimensions in the decomposition of a tensor product of representations in irreps; Kronecker coefficients are still under active investigation in Combinatorics and Computational Complexity Theory, see, for instance, [39, 40] and more references therein), each square matching exactly the dimension of a matrix subalgebra. The orthogonal bases of the algebra and its matrix subalgebras have been worked out, meanwhile the Gaussian 2pt-correlators also provide new representation theoretic orthogonal bases.

In this paper, we consider $O(N)$ tensor models and their observables and investigate if they support the same previous enumeration and algebraic analysis. Fleshed out the first time in [41], such models extended the large N expansion to real tensors. The graphs that determine the $O(N)$ invariants keep the edge coloring but are not bipartite. This naturally leads to a class of observables, wider than that of the $U(N)$ tensor models, by including those that are not orientable. To enumerate $O(N)$ invariants, we use a standard counting recipe: we use tuples of permutations on which act permutation (sub)groups that define equivalence classes. We then count the points in the resulting a double coset space. The equivalence relation in the present setting is radically different from the $U(N)$ situation and requires more work to obtain a valuable counting formula. With their generating functions in hand, we provide software (Mathematica, Sage) codes to achieve the counting of $O(N)$ observables for any tensor rank. We emphasize that our results match the seminal work of Read in [42] that dealt with the enumeration k -regular graphs with $2n$ vertices with k edge coloring. However, Read's formula was only evaluated for the $k = 3$ -regular graphs with $2n = 2, 4, 6$ vertices with edges of 3 different colors. Our code extends this counting for any k and

any n . We produce integer sequences that are new (un-reported yet) to the On-Line Encyclopedia of Integer Sequences [43].

Moreover, seeking other correspondences, we address the TFT formulation of our counting and show that to count $O(N)$ observables amounts to count covers of glued cylinders with defects (the rank of tensor relates to the number cylinders and defects). After introducing the algebra of $O(N)$ invariants, we show that it is semi-simple, and as such, it admits a Wedderburn-Artin decomposition. An invariant orthogonal base of the algebra transpires in our analysis but, it does not yield the decomposition of the algebra in matrix subalgebras. We proceed to the representation theoretic formulation of the counting and its consequences. As to be distinguished from the $U(N)$ case, the dimension of the algebra is a sum of constrained Kronecker coefficients restricted to partitions with all even length rows. The representation theoretic tools exhibit a base of the algebra the dimension of which directly reflects the sums of constrained Kronecker's. The Gaussian 2pt and 1pt-correlators also compute in terms of permutation group formulae. A corollary of that analysis is that 2pt-functions, in the normal order, select a representation theoretic orthogonal base of the algebra. In that sense, the Gaussian integration in the representation Fourier space performs as a pairing of observables.

This paper's structure follows. Section 2 sets up our notations for real tensor models and their $O(N)$ invariants. The following Section 3 develops the double coset counting using permutation group formalism. We also discuss therein the TFT formulation of the counting and its consequences, introduce the basics of the representation theory of the symmetric group, and re-interpret the counting in that language. Section 4 discusses the double coset algebra built out of the $O(N)$ invariants and lists its properties. Next, Section 5 details the 2pt- and 1pt-correlators of the Gaussian tensor models and their representation theoretic consequences. Section 6 briefly lists a few remarks on the counting of invariants of the real symplectic group $Sp(2N)$. The counting principle here is similar to that of the $O(N)$ models, but with subtleties that one should pay attention to. Section 7 summarizes this work and draws some of its perspectives. Finally, the paper closes with an appendix that divides into two main parts: an appendix that collects identities of the representation theory of the symmetric group that are useful in the text, and another appendix that details the software codes that generate the sequences of numbers of invariants at sundry tensor ranks $d = 3, 4, \dots$

2. $O(N)$ invariants and real tensor models

We first set up our notations in this part.

Consider $d \geq 2$ real vector spaces V_a , $a = 1, \dots, d$, of respective dimensions N_a , and the group action $\otimes_{a=1}^d O(N_a)$ on $\otimes_{a=1}^d V_a$. Let T be a tensor of rank d with components T_{i_1, \dots, i_d} transforming under the tensor product of d fundamental representations of the groups $O(N_a)$. Each group $O(N_a)$ acts independently on a tensor index i_a and we can write

$$(1) \quad T_{i_1, \dots, i_d}^O = \sum_{j_1, \dots, j_d} O_{i_1 j_1}^{(1)} O_{i_2 j_2}^{(2)} \dots O_{i_d j_d}^{(d)} T_{j_1 j_2 \dots j_d}.$$

The observables in this model are the contractions of an even number, say $2n$ with $n \in \mathbb{N}$, of tensors T which are obviously invariant under $\otimes_{a=1}^d O(N_a)$ transformations. We simply name them $O(N)$ invariants. Such invariants generalize real matrix traces and will be denoted likewise:

$$O_K(T) = \text{Tr}(T^{2n}) = \sum_{j_l^{(k)}} T_{j_1^{(1)} j_2^{(1)} \dots j_d^{(1)}} T_{j_1^{(2)} j_2^{(2)} \dots j_d^{(2)}} \dots T_{j_1^{(2n)} j_2^{(2n)} \dots j_d^{(2n)}} \times K(\{j_l^{(1)}\}; \{j_l^{(2)}\}; \dots; \{j_l^{(2n)}\}),$$

where the kernel $K(\cdot)$ factors in Kronecker delta's and identifies the indices of the tensors in a particular pattern; the sole contractions permitted involve the tensor indices with identical color labels $i = 1, \dots, d$. An elegant way of encoding the contraction pattern of tensors consists in a d -regular graph with edge coloring with d different colors, and one of each color at every vertex (representing each tensor). Calling b the colored graph, the invariant denotes equivalently $O_K(T) = O_b(T)$. We will detail this in the next section.

We build a physical model by introducing a partition function

$$(2) \quad Z = \int d\nu(T) \exp(-S_N(T)),$$

where the action $S_N(T) = \sum_b \lambda_b N^{-\rho(b)} O_b(T)$ is defined as a finite sum over some $O(N)$ tensor invariants representing the model interactions each with coupling λ_b and $\rho(b)$ scaling parameter; $d\nu(T)$ is a tensor field measure.

In this work, we will consider only correlators that are Gaussian. This means that the field measure will be Gaussian and of the form

$$(3) \quad d\nu(T) = \prod_{j_l} dT_{j_1 j_2 \dots j_d} e^{-O_2(T)}, \quad O_2(T) = \sum_{j_k} (T_{j_1 j_2 \dots j_d})^2.$$

In other terms, $O_2(T)$ plays the role of a quadratic mass term. The free propagator of the Gaussian measure is given by

$$(4) \quad \langle T_{i_1 i_2 \dots i_d} T_{j_1 j_2 \dots j_d} \rangle = \int d\nu(T) T_{i_1 i_2 \dots i_d} T_{j_1 j_2 \dots j_d} = \delta_{i_1 j_1} \delta_{i_2 j_2} \dots \delta_{i_d j_d},$$

and will be used in the Wick theorem for computing Gaussian correlators. We will be interested in the mean values of observables that are defined by

$$(5) \quad \begin{aligned} \langle O_b(T) \rangle &= \frac{1}{\int d\nu(T)} \int d\nu(T) O_b(T), \\ \langle O_b(T) O_{b'}(T) \rangle &= \frac{1}{\int d\nu(T)} \int d\nu(T) O_b(T) O_{b'}(T). \end{aligned}$$

The second correlator will be restricted to normal order allowing only Wick contractions from $O_b(T)$ to $O_{b'}(T)$. In Section 5, enlightened by the symmetric group formulation of the $O(N)$ invariants, we will reformulate (5) and analyse the representation algebraic structure brought by the 2pt-correlator. The first correlator is sketched as it evaluates by modifying the previous calculation method.

3. Counting $O(N)$ invariants

Counting the number of invariants based on the contractions of $2n$ copies of tensors T_{i_1, \dots, i_d} , starts by a symmetric group construction. Actually, this enumeration problem expresses as a permutation-TFT that we also discuss. Finally, switching to representation theory, we derive the same counting formula in terms of the famous Kronecker coefficients.

3.1. Enumeration of rank $d \geq 3$ tensor invariants

Orthogonal invariants are in one-to-one in correspondence with d -regular colored graphs (see for instance [41]). Contrary to the graphs corresponding to unitary invariants [7, 20], the present graphs are not bipartite and, so, might be non-orientable. It is always possible to make a graph bipartite by inserting another type of vertex of valence 2 called “black” (henceforth the initial vertices are called “white”) on each edge of the graph. We therefore perform that transformation and the new vertices are denoted v_i^j , $i = 1, \dots, 2n$ (recall that $2n$ is the number of tensors) and $j = 1, \dots, d$. The resulting graph is neither regular, nor properly edge-colored. It is however

bipartite as illustrated in Figure 1. This property concedes a description of a colored graph in symmetric groups language.

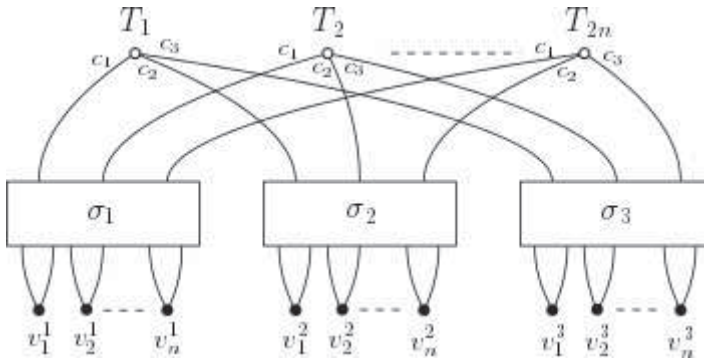

Figure 1. Rank $d = 3$ orthogonal tensor contractions.

We shall focus on $d = 3$. The general case d will follow from this case. We denote S_{2n} the symmetric group of order $(2n)!$. Counting possible graphs consists of enumerating the triples

$$(6) \quad (\sigma_1, \sigma_2, \sigma_3) \in S_{2n} \times S_{2n} \times S_{2n}$$

subjected to the equivalence

$$(7) \quad (\sigma_1, \sigma_2, \sigma_3) \sim (\gamma_1 \sigma_1 \gamma, \gamma_2 \sigma_2 \gamma, \gamma_3 \sigma_3 \gamma),$$

where $\gamma \in S_{2n}$ and the γ_i belong to the so-called wreath product subgroup $\in S_n[S_2] \subset S_{2n}$. We intend to count the points in the double coset

$$(8) \quad (S_n[S_2] \times S_n[S_2] \times S_n[S_2]) \backslash (S_{2n} \times S_{2n} \times S_{2n}) / \text{Diag}(S_{2n}).$$

Let us denote $Z_3(2n)$ the cardinality of this double coset.

In a broader setting [42], for two subgroups $H_1 \subset G$ and $H_2 \subset G$, the cardinality of the double coset $|H_1 \backslash G / H_2|$ is given by

$$(9) \quad |H_1 \backslash G / H_2| = \frac{1}{|H_1||H_2|} \sum_C Z_C^{H_1 \rightarrow G} Z_C^{H_2 \rightarrow G} \text{Sym}(C).$$

The sum is over conjugacy classes of G , and $Z_C^{H \rightarrow G}$ is the number of elements of H in the conjugacy class C of G .

The conjugacy classes of $S_{2n} \times S_{2n} \times S_{2n}$ are determined by triples (p_1, p_2, p_3) , where each p_i is a partition of $2n$. The presence of the subgroup $\text{Diag}(S_{2n})$ implies that only conjugacy classes determined by a triple (p, p, p) should be conserved in the above sum.

Applying (9), we get

$$\begin{aligned} Z_3(2n) &= \frac{1}{[n!(2!)^n]^3(2n)!} \sum_{p \vdash 2n} Z_{(p,p,p)}^{(S_n[S_2])^{\times 3} \rightarrow (S_{2n})^{\times 3}} \times \left(\frac{(2n)!}{\text{Sym}(p)} \right) (\text{Sym}(p))^3 \\ &= \frac{1}{[n!(2!)^n]^3} \sum_{p \vdash 2n} Z_{(p,p,p)}^{(S_n[S_2])^{\times 3} \rightarrow (S_{2n})^{\times 3}} \times (\text{Sym}(p))^2 \\ (10) \quad &\text{with } \text{Sym}(p) := \prod_{i=1}^n (i^{p_i})(p_i!), \end{aligned}$$

and where the sum over $p = (p_\ell)_\ell$ is performed over all partitions of $2n = \sum_i ip_i$. The cardinality of a conjugacy class T_p of S_{2n} with cycle structure determined by a partition p is given by $|T_p| = (2n)!/\text{Sym}(p)$. Next, we must determine the size of $Z_{(p,p,p)}^{(S_n[S_2])^{\times 3} \rightarrow (S_{2n})^{\times 3}}$ which is

$$(11) \quad Z_{(p,p,p)}^{(S_n[S_2])^{\times 3} \rightarrow (S_{2n})^{\times 3}} = (Z_p^{S_n[S_2] \rightarrow S_{2n}})^3.$$

We can get a single factor in this product as

$$(12) \quad \frac{1}{n!(2!)^n} Z_p^{S_n[S_2] \rightarrow S_{2n}} = \text{Coefficient} [Z_2^{S_\infty[S_2]}(t, \vec{x}), t^n x_1^{p_1} x_2^{p_2} \dots x_{2n}^{p_{2n}}],$$

where appears the generating function of the number of wreath product elements in a certain conjugacy class $p \vdash 2n$, namely

$$(13) \quad Z_d^{S_\infty[S_d]}(t, \vec{x}) = \sum_n t^n Z_n^{S_n[S_d]}(\vec{x}) = e^{\sum_{i=1}^\infty \frac{t^i}{i}} \left[\sum_{q \vdash d} \prod_{\ell=1}^d \left(\frac{x_{i\ell}}{\ell} \right)^{\nu_\ell} \frac{1}{\nu_\ell!} \right],$$

where $\vec{x} = (x_1, x_2, \dots)$, and $q = (\nu_\ell)_\ell$ is a partition of d , such that $\sum_\ell \ell \nu_\ell = d$.

The expression (10) finally computes to

$$(14) \quad Z_3(2n) = \sum_{p \vdash 2n} (\text{Coefficient} [Z_2^{S_\infty[S_2]}(t, \vec{x}), t^n x_1^{p_1} x_2^{p_2} \dots x_{2n}^{p_{2n}}])^3 (\text{Sym}(p))^2.$$

In general, for arbitrary d , the above calculation is straightforward and yields, for any $d \geq 2$,

$$(15) \quad Z_d(2n) = \sum_{p \vdash 2n} (\text{Coefficient } [Z_2^{S_\infty[S_2]}(t, \vec{x}), t^n x_1^{p_1} x_2^{p_2} \dots x_{2n}^{p_{2n}}])^d \times (\text{Sym}(p))^{d-1}.$$

We can generate the sequences $Z_3(2n)$ and $Z_4(2n)$ (both with $n = 1, \dots, 10$) using a Mathematica program in Appendix B and obtain, respectively,

$$(16) \quad 1, 5, 16, 86, 448, 3580, 34981, 448628, 6854130, 121173330$$

and

$$(17) \quad \begin{aligned} &1, 14, 132, 4154, 234004, 24791668, 3844630928, 809199787472, \\ &220685007519070, 75649235368772418. \end{aligned}$$

Following Read [42], the number $Z_d(2n)$ of d -regular colored graphs made with $2n$ vertices is the coefficient of t^n in $\prod_m \Phi_m(t)$, with m sufficiently large to collect all such coefficients, and where

$$(18) \quad \Phi_m(t) = \begin{cases} \sum_{j=0}^{\infty} \frac{(A_{m/2}(j))^d}{j! m^j} t^{mj/2} & \text{if } k = 1, \\ \sum_{j=0}^{\infty} \frac{(2j)^{d-1}}{j! t^d} \left(\frac{m^{d-2}}{2^k}\right)^j t^{mj} & \text{if } m \text{ is odd,} \end{cases}$$

and the function $A_k(j)$ is related to the j -th Hermite polynomial by $A_k(j) = (i\sqrt{k})^j H_j(\frac{1}{2i\sqrt{k}})$.

We generate the corresponding sequences $Z_3(2n)$, $n = 1, \dots, 10$, and $Z_4(2n)$, $n = 1, \dots, 10$, using a Mathematica program (in Appendix B) and the results match with (16) and (17), respectively. Hence, both methods yield the same results. The sequence (16) naturally corresponds to the OEIS sequence A002830 (number of 3-regular edge colored graphs with $2n$ nodes) [43]. The sequence (17) is not yet reported on the OEIS. Hence, the formula (15) generates arbitrary new sequences for each $d > 3$.

We must underline that the above counting of observables concerns connected and disconnected graphs (generalized multi-matrix invariants). To obtain only connected invariants, we use the plethystic logarithm (Plog) transform on the generating series of the disconnected invariants. Such a generating function also easily programs with the Möbius μ -function. We obtain the enumeration of connected invariants (see Appendix B) for rank

$d = 3$ and 4 , respectively, up to order $n = 10$ as,

$$(19) \quad 1, 4, 11, 60, 318, 2806, 29359, 396196, 6231794, 112137138,$$

and

$$(20) \quad 1, 13, 118, 3931, 228316, 24499085, 3816396556, 805001547991, \\ 219822379032704, 75417509926065404.$$

As an illustration, Figure 2 depicts the rank 3 connected orthogonal invariants up to valence 6. The colors $c_i = 1, 2, 3$, should be permuted to generate the full set of connected invariants.

3.2. TFT formulation

From the above symmetric group formulation of the counting of tensor invariants, one extracts more information via other correspondences. In particular, the enumeration reformulates as a partition function of a Topological Field Theory on a 2-complex (in short TFT_2) with S_{2n} and its subgroup $S_n[S_2]$ as gauge groups. For a review of TFT's, see [44, 45] and, in notation closer to what we aim at, see [25, 26].

Consider the counting of classes in the double coset (8), denote it as $Z_3(2n)$, and then consider the relation (9). Using Burnside's lemma, we have in standard notations:

$$(21) \quad Z_3(2n) = \frac{1}{[n!(2!)^n]^3(2n)!} \\ \times \sum_{\gamma_i \in S_n[S_2]} \sum_{\sigma_i \in S_{2n}} \sum_{\gamma \in S_{2n}} \delta(\gamma_1 \sigma_1 \gamma \sigma_1^{-1}) \delta(\gamma_2 \sigma_2 \gamma \sigma_2^{-1}) \delta(\gamma_3 \sigma_3 \gamma \sigma_3^{-1}),$$

where δ is the Kronecker symbol on S_{2n} . This counting interprets as a partition function of a TFT_2 on a cellular complex given by Figure 3. On that lattice, we use two gauge groups S_{2n} and $S_n[S_2]$. The topology of that 2-complex is that of three cylinders sharing the same end circle. Thus, enumerating orthogonal invariant corresponds to a S_{2n} - TFT_2 on 3 glued cylinders along one circle, with a restriction of the gauge group to be $S_n[S_2]$ at the opposite boundary circle. This TFT_2 has boundary holonomies endowed with $S_n[S_2]$ group elements.

By successively integrating some delta functions, the TFT_2 formulation produces alternative interpretations of the same counting. We extract γ from

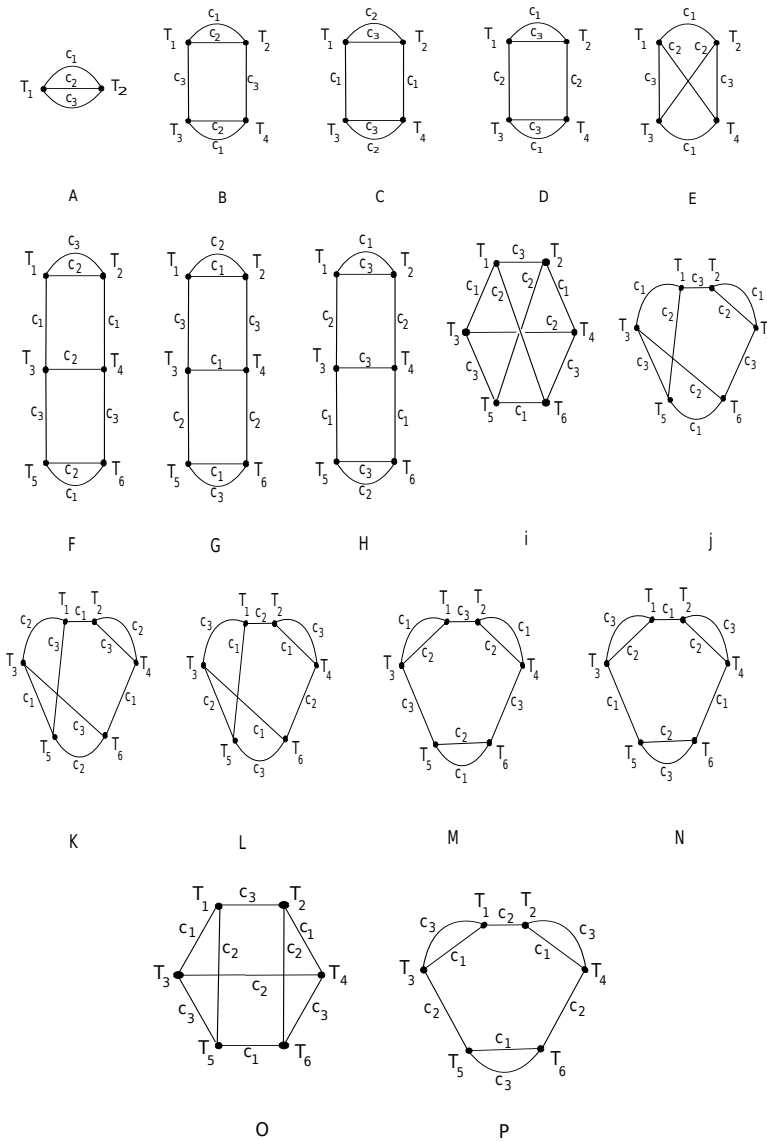

Figure 2. Connected colored graphs associated with rank 3 orthogonal tensor invariants with up to 6 vertices.

(21) and get $\gamma = \sigma_3^{-1} \gamma_3^{-1} \sigma_3$ such that

$$Z_3(2n) = \frac{1}{[n!(2!)^n]^3 (2n)!}$$

$$(22) \quad \times \sum_{\gamma_i \in S_n} \sum_{[S_2]} \delta(\gamma_1 \sigma_1 (\sigma_3^{-1} \gamma_3^{-1} \sigma_3) \sigma_1^{-1}) \delta(\gamma_2 \sigma_2 (\sigma_3^{-1} \gamma_3^{-1} \sigma_3) \sigma_2^{-1}).$$

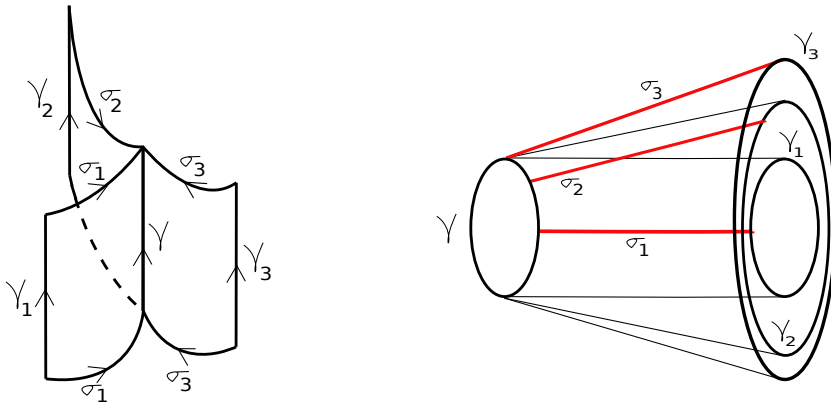

Figure 3. TFT_2 associated with the counting of orthogonal invariants.

A change of variables $\sigma_{1,2} \rightarrow \sigma_{1,2}\sigma_3^{-1}$ leads us to

$$(23) \quad Z_3(2n) = \frac{1}{[n!(2!)^n]^3} \sum_{\gamma_i \in S_n[S_2]} \sum_{\sigma_{1,2} \in S_{2n}} \delta(\gamma_1\sigma_1\gamma_3\sigma_1^{-1})\delta(\gamma_2\sigma_2\gamma_3\sigma_2^{-1}).$$

This integration illustrates, in Figure 4, as the removal of a 1-cell associated with the variable γ in the 2-complex. The partition function therefore shows two types of invariances: the extraction of γ corresponds to one type of topological invariance, and then, it is followed by the change of variables $\sigma_{1,2} \rightarrow \sigma_{1,2}\sigma_3^{-1}$ corresponding to a topological invariance of a second kind.

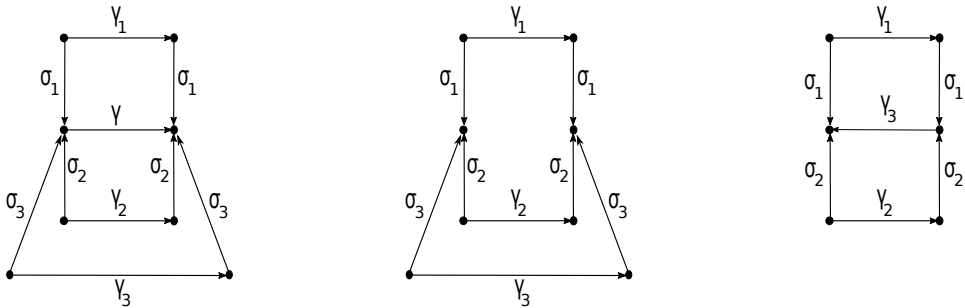

Figure 4. Topological transformations of the 2-complex leaving the partition function stable.

Thus, the partition function (23) can also be written as

$$(24) \quad Z_3(2n) = Z(S^1 \times I; (D_{S_n[S_2]})^{\times 3}),$$

where $Z(S^1 \times I; (D_{S_n[S_2]})^{\times 3})$ is the partition function obtained by inserting 3 $S_n[S_2]$ -defects, one at each end of the cylinder $S^1 \times I$, and another one at finite time $t_0 \in I$, see Figure 5. A defect defines as a closed non-intersecting loop with a marked point. The relation (24) shows that orthogonal invariants are in one-to-one correspondence with n -fold covers of the cylinder with 3 defects, up to a (symmetry) factor, the stabilizer subgroup of the graph that we denote $\text{Aut}(G_{\sigma_1, \sigma_2, \sigma_3})$.

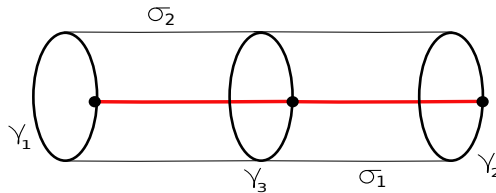

Figure 5. Cylinder with 3 defects.

The order of the stabilizer infers from

$$(25) \quad \text{Sym}(\sigma_1, \sigma_2) = \sum_{\gamma_i \in S_n[S_2]} \delta(\gamma_1 \sigma_1 \gamma_3 \sigma_1^{-1}) \delta(\gamma_2 \sigma_2 \gamma_3 \sigma_2^{-1}) = \text{Aut}(G_{\sigma_1, \sigma_2, \sigma_3})$$

which also relates to the number of equivalences $(S_n[S_2] \times S_n[S_2]) \setminus (S_n \times S_n) / \text{Diag}(S_n[S_2])$ corresponding to a fixed (σ_1, σ_2) .

The TFT formulation of the counting could enrich it with a geometrical picture. Most of the time, the base space of the TFT is viewed as a string worldsheet. The counting becomes now counting of worldsheet maps over a cylinder with defects. As noticed elsewhere [20, 35], this once again shows that a link may exist between tensor models and string theory, which could be elucidated via the TFT formalism. Such link may be worth investigating in the future.

Rank d counting and TFT_2 – More generally, for rank $d \geq 3$, the counting $Z_d(2n)$ has a TFT_2 formulation that generalizes what we discuss above in a straightforward manner:

$$(26) \quad Z_d(2n) = \frac{1}{[n!(2!)^n]^d (2n)!} \sum_{\gamma_i \in S_n[S_2]} \sum_{\sigma_i \in S_{2n}} \sum_{\gamma \in S_{2n}} \prod_{i=1}^d \delta(\gamma_i \sigma_i \gamma \sigma_i^{-1})$$

$$= \frac{1}{[n!(2!)^n]^d} \sum_{\gamma_i \in S_n[S_2]} \sum_{\sigma_i \in S_{2n}} \prod_{i=1}^{d-1} \delta(\gamma_i \sigma_i \gamma_d \sigma_i^{-1}).$$

The first equation of (26) shows that, in rank d , the TFT_2 -formulation of the counting extends Figure 3 as the gluing of d cylinders along one circle. After integration, the second equations reveals that the counting orthogonal invariants amounts therefore counting of weighted covers of $d - 1$ cylinders with d defects, with one of the defects shared by all cylinders. In formula, we have $Z_d(2n) = Z(S^1 \times I; (D_{S_n[S_2]})^{\times d})$.

3.3. The counting as a Kronecker sum

We now revisit the counting (21) under a different light, that of the representation theory of the symmetric group (Appendix A reviews the main identities used in this section and the following). Irreducible representations (irreps) of the symmetric group S_{2n} are labeled by partitions $R \vdash 2n$, that are also Young diagrams.

Starting from the Burnside lemma formulation of the counting (21), consider the following expansion of the counting of rank 3 invariants using the representation theory of S_{2n} :

$$\begin{aligned}
 Z_3(2n) &= \frac{1}{[n!(2!)^n]^3 (2n)!} \\
 &\quad \times \sum_{\gamma_1 \in S_n[S_2]} \sum_{\sigma_1 \in S_{2n}} \sum_{\gamma \in S_{2n}} \delta(\gamma_1 \sigma_1 \gamma \sigma_1^{-1}) \delta(\gamma_2 \sigma_2 \gamma \sigma_2^{-1}) \delta(\gamma_3 \sigma_3 \gamma \sigma_3^{-1}) \\
 &= \frac{1}{[n!(2!)^n]^3 (2n)!} \\
 &\quad \times \sum_{\gamma_1 \in S_n[S_2]} \sum_{\gamma \in S_{2n}} \sum_{R_i \vdash 2n} \chi^{R_1}(\gamma_1) \chi^{R_1}(\gamma) \chi^{R_2}(\gamma_2) \chi^{R_2}(\gamma) \chi^{R_3}(\gamma_3) \chi^{R_3}(\gamma) \\
 &= \frac{1}{[n!(2!)^n]^3} \\
 (27) \quad &\quad \times \sum_{R_i \vdash 2n} \mathbf{C}(R_1, R_2, R_3) \left[\sum_{\gamma_1 \in S_n[S_2]} \chi^{R_1}(\gamma_1) \right] \left[\sum_{\gamma_2 \in S_n[S_2]} \chi^{R_2}(\gamma_2) \right]
 \end{aligned}$$

where $\chi^R(\cdot)$ denotes the character in the representation R ; we used the identity (A.4) in Appendix A.1 to compute the delta's, and the Kronecker coefficient is defined as

$$(28) \quad \mathbf{C}(R_1, R_2, R_3) = \frac{1}{2n!} \sum_{\gamma \in S_{2n}} \chi^{R_1}(\gamma) \chi^{R_2}(\gamma) \chi^{R_3}(\gamma).$$

The Kronecker defines the multiplicity of the representation R_3 in the tensor product $R_1 \otimes R_2$, or the multiplicity of the trivial representation in $R_1 \otimes R_2 \otimes R_3$ when expanded back in irreps.

Above, the sums over the subgroup $S_n[S_2]$ have been not yet performed. To proceed with these sums, we will use a useful result by Howe [46] (see also a result by Mizukawa, proposition 4.1 in [47], and also [48, 49] or a more recent use of it in [30]):

$$(29) \quad \sum_{\gamma \in S_n[S_2]} \chi^R(\gamma) = |S_n[S_2]| m^R$$

where $m^R = 1$ if R is an “even” partition, that is, all its row lengths are even, and $m^R = 0$ otherwise. This result is derived from a more general formula $\sum_{\gamma \in S_n[S_2]} \chi^A(\gamma) \chi^R(\gamma) = |S_n[S_2]| m^{A|R}$, where A is an irrep of $S_n[S_2]$ subduced by R irreps of S_{2n} , and then inserting A as the trivial representation $\overline{[2n]}$ of $S_n[S_2]$.

Then, we obtain, inserting this in (27)

$$(30) \quad Z_3(2n) = \sum_{R_i \vdash 2n/R_i \text{ is even}} \mathbf{C}(R_1, R_2, R_3).$$

Comparing this sequence and (16), we produce a Sage code (see Appendix B) showing that the numbers generated by (30) match with (16).

In the next section, we will show that, this number is also the dimension of an algebra $\mathcal{K}_3(n)$. It is an interesting problem to investigate how the counting of colored graphs could contribute to the famous problem of giving a combinatorial interpretation to the Kronecker coefficients [39, 40] (in the same way that Littlewood-Richardson coefficient have found a combinatorial description). From previous work [35], we know that the sum of squares of Kronecker coefficients associated with S_n equals the number of d -regular bipartite colored graphs made with n black and n white vertices. Here the interpretation is the following, the number of d -regular colored graphs (not necessarily bipartite) equals the sum of all Kronecker’s precluded those that are defined with partitions with odd rows. An idea to contribute to the above problem is to refine the counting of graphs in a way to boil down to a single Kronecker coefficient. In other words, given a non vanishing Kronecker coefficient is it possible to list all graphs contributing to that Kronecker coefficient? This is certainly a difficult problem that will require new tools in representation theory.

Counting rank- d tensor invariants - The above counting generalize quite naturally at any rank d as

$$\begin{aligned}
 (31) \quad Z_d(2n) &= \frac{1}{[n!(2!)^n]^d (2n)!} \sum_{\gamma_l \in S_n[S_2]} \sum_{\sigma_l \in S_{2n}} \sum_{\gamma \in S_{2n}} \prod_{i=1}^d \delta(\gamma_i \sigma_i \gamma \sigma_i^{-1}) \\
 &= \frac{1}{[n!(2!)^n]^d} \sum_{R_l \vdash 2n} \sum_{\gamma_l \in S_n[S_2]} \mathbf{C}_d(R_1, \dots, R_d) \chi^{R_1}(\gamma_1) \dots \chi^{R_d}(\gamma_d) \\
 &= \sum_{R_l \vdash 2n / R_l \text{ is even}} \sum_{\gamma_l \in S_n[S_2]} \mathbf{C}_d(R_1, \dots, R_d)
 \end{aligned}$$

where we introduced the notation

$$(32) \quad \mathbf{C}_k(R_1, \dots, R_k) = \frac{1}{(2n)!} \sum_{\gamma \in S_{2n}} \chi^{R_1}(\gamma) \dots \chi^{R_k}(\gamma).$$

This counts the multiplicity of the one dimensional trivial S_{2n} irrep in the tensor product of irreps $R_1 \otimes \dots \otimes R_k$. It expresses as a convoluted product of Kronecker coefficients as

$$\begin{aligned}
 (33) \quad \mathbf{C}_k(R_1, \dots, R_k) &= \sum_{S_l \vdash 2n} \mathbf{C}(R_1, R_2, S_1) \\
 &\quad \times \left[\prod_{i=1}^{k-4} \mathbf{C}(S_i, R_{i+2}, S_{i+1}) \right] \mathbf{C}(S_{k-3}, R_{k-1}, R_k).
 \end{aligned}$$

4. Double coset algebra

We now discuss the underlying structure, an algebra, determined by the counting of the $O(N)$ invariants. The rank 3 case is first addressed for the sake of simplicity, and from that, we will infer the general rank- d case whenever possible.

Consider $\mathbb{C}[S_{2n}]$, the group algebra of S_{2n} . Our construction depends on tensor products of that space.

$\mathcal{K}_d(2n)$ as a double coset algebra in $\mathbb{C}[S_{2n}]^{\otimes d}$ - We fix $d = 3$. Consider $\sigma_1 \otimes \sigma_2 \otimes \sigma_3$ as an element of the group algebra $\mathbb{C}[S_{2n}]^{\otimes 3}$, and three left actions of the subgroup $S_n[S_2]$ and the diagonal right action $\text{Diag}(\mathbb{C}(S_{2n}))$ on this triple as:

$$(34) \quad \sigma_1 \otimes \sigma_2 \otimes \sigma_3 \rightarrow \sum_{\gamma_i \in S_n[S_2]} \sum_{\gamma \in S_{2n}} \gamma_1 \sigma_1 \gamma \otimes \gamma_2 \sigma_2 \gamma \otimes \gamma_3 \sigma_3 \gamma.$$

$\mathcal{K}_3(2n)$ is the vector subspace of $\mathbb{C}[S_{2n}]^{\otimes 3}$ which is invariant under these subgroup actions:

$$(35) \quad \mathcal{K}_3(2n) = \text{Span}_{\mathbb{C}} \left\{ \sum_{\gamma_i \in S_n[S_2]} \sum_{\gamma \in S_{2n}} \gamma_1 \sigma_1 \gamma \otimes \gamma_2 \sigma_2 \gamma \otimes \gamma_3 \sigma_3 \gamma, \quad \sigma_1, \sigma_2, \sigma_3 \in S_{2n} \right\}$$

It is obvious that $\dim \mathcal{K}_3(2n) = Z_3(2n)$, since each base element represents the graph equivalent class counted once in $Z_3(2n)$. Pick two base elements, called henceforth graph base elements, and consider their product

$$(36) \quad \begin{aligned} & \left[\sum_{\gamma_i \in S_n[S_2]} \sum_{\gamma \in S_{2n}} \gamma_1 \sigma_1 \gamma \otimes \gamma_2 \sigma_2 \gamma \otimes \gamma_3 \sigma_3 \gamma \right] \\ & \times \left[\sum_{\tau_i \in S_n[S_2]} \sum_{\tau \in S_{2n}} \tau_1 \sigma'_1 \tau \otimes \tau_2 \sigma'_2 \tau \otimes \tau_3 \sigma'_3 \tau \right] \\ & = \sum_{\gamma_i, \tau_i \in S_n[S_2]} \sum_{\gamma, \tau \in S_{2n}} \gamma_1 \sigma_1 \gamma \tau_1 \sigma'_1 \tau \otimes \gamma_2 \sigma_2 \gamma \tau_2 \sigma'_2 \tau \otimes \gamma_3 \sigma_3 \gamma \tau_3 \sigma'_3 \tau \\ & = \sum_{\tau_i \in S_n[S_2]} \sum_{\gamma \in S_{2n}} \left[\sum_{\gamma_i \in S_n[S_2]} \sum_{\tau \in S_{2n}} \right. \\ & \quad \left. \gamma_1 (\sigma_1 \gamma \tau_1 \sigma'_1) \tau \otimes \gamma_2 (\sigma_2 \gamma \tau_2 \sigma'_2) \tau \otimes \gamma_3 (\sigma_3 \gamma \tau_3 \sigma'_3) \tau \right] \end{aligned}$$

This shows that the multiplication remains in the vector space. Hence, $\mathcal{K}_3(2n)$ is an algebra and (36) defines a graph multiplication. The proof is totally similar for $\mathcal{K}_d(2n)$ (considering d factors in the tensor product) which is thus an algebra of dimension $Z_d(2n)$.

The product of graphs in the algebra $\mathcal{K}_3(2n)$ illustrates as in Figure 6.

Gauge fixing - There is a gauge fixing procedure in the construction of orthogonal invariants. One initially fixes a permutation σ_i but is still able to generate all invariants. Consider $\xi = (12)(34) \dots (2n - 1, 2n)$, and we fix σ_1 to belong to the stabilizer of ξ , i.e. $\sigma_1^{-1} \xi \sigma_1 = \xi$. Since the $\text{Stab}_{\xi} = S_n[S_2]$, we simply mean that we choose σ_1 to be in that subgroup. We already observe a difference with the unitary case [35]. Indeed, while the gauge fixing in the unitary case leads to the definition of a permutation centralizer algebra, the gauge fixing here will not bring such an algebra. The main difference with the unitary case also rests on the fact that the left and right invariances on the triple $(\sigma_1, \sigma_2, \sigma_3)$ in this case are radically different.

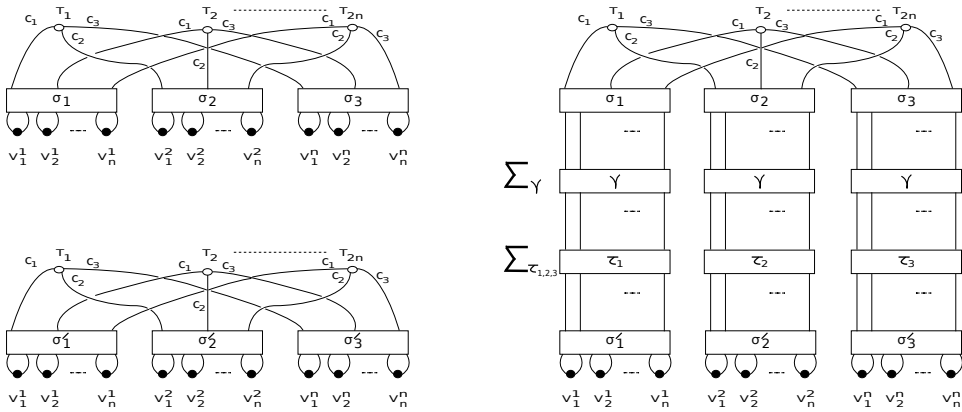

Figure 6. Product of two graph base elements (on the left) gives a sum of graphs (on the right).

Associativity - In the graph base, we can check the associativity of the product of elements of $\mathcal{K}_3(2n)$:

$$\begin{aligned}
 (37) \quad & \left(\left[\sum_{\gamma_i \in S_n[S_2]} \sum_{\gamma \in S_{2n}} \gamma_1 \sigma_1 \gamma \otimes \gamma_2 \sigma_2 \gamma \otimes \gamma_3 \sigma_3 \gamma \right] \right. \\
 & \times \left. \left[\sum_{\tau_i \in S_n[S_2]} \sum_{\tau \in S_{2n}} \tau_1 \sigma'_1 \tau \otimes \tau_2 \sigma'_2 \tau \otimes \tau_3 \sigma'_3 \tau \right] \right) \\
 & \times \left[\sum_{\alpha_i \in S_n[S_2]} \sum_{\alpha \in S_{2n}} \alpha_1 \sigma''_1 \alpha \otimes \alpha_2 \sigma''_2 \alpha \otimes \alpha_3 \sigma''_3 \alpha \right] \\
 & = \sum_{\tau_i, \alpha_i} \sum_{\gamma, \tau} \left[\sum_{\gamma, \alpha} \gamma_1 \sigma_1 \gamma \tau_1 \sigma'_1 \tau \alpha_1 \sigma''_1 \alpha \right. \\
 & \quad \left. \otimes \gamma_2 \sigma_2 \gamma \tau_2 \sigma'_2 \tau \alpha_2 \sigma''_2 \alpha \otimes \gamma_3 \sigma_3 \gamma \tau_3 \sigma'_3 \tau \alpha_3 \sigma''_3 \alpha \right] \\
 & = \left[\sum_{\gamma_i \in S_n[S_2]} \sum_{\gamma \in S_{2n}} \gamma_1 \sigma_1 \gamma \otimes \gamma_2 \sigma_2 \gamma \otimes \gamma_3 \sigma_3 \gamma \right] \\
 & \times \left(\left[\sum_{\tau_i \in S_n[S_2]} \sum_{\tau \in S_{2n}} \tau_1 \sigma'_1 \tau \otimes \tau_2 \sigma'_2 \tau \otimes \tau_3 \sigma'_3 \tau \right] \right. \\
 & \quad \left. \times \left[\sum_{\alpha_i \in S_n[S_2]} \sum_{\alpha \in S_{2n}} \alpha_1 \sigma''_1 \alpha \otimes \alpha_2 \sigma''_2 \alpha \otimes \alpha_3 \sigma''_3 \alpha \right] \right)
 \end{aligned}$$

The proof easily extends to any d , and we therefore claim the following:

Proposition 4.1. $\mathcal{K}_d(2n)$ is an associative unital sub-algebra of $\mathbb{C}[S_{2n}]^{\otimes 3}$.

The unity is given by the equivalence class of (id, id, id) . Such element corresponds to the disconnected graph made with n connected components with full contraction of n pairs of tensors.

Pairing - There is an inner product (that we will call pairing) on $\mathcal{K}_d(2n)$ defined from the linear extension of the delta function from the symmetric group to the tensor product group algebra (see (A.22) in Appendix A.3 for details pertaining to the following notation). Take two base elements (in obvious notation) and evaluate using proper change of variables:

$$\begin{aligned}
 (38) \quad \delta\left(\sum_{\gamma_i, \gamma} \otimes_i^d \gamma_i \sigma_i \gamma; \sum_{\tau_i, \tau} \otimes_i^d \tau_i \sigma'_i \tau\right) &= \sum_{\gamma_i, \gamma} \sum_{\tau_i, \tau} \prod_i^d \delta(\gamma_i \sigma_i \gamma (\tau_i \sigma'_i \tau)^{-1}) \\
 &= [(2n)!(n!2^n)] \sum_{\gamma_i, \gamma} \prod_i^d \delta(\gamma_i \sigma_i \gamma (\sigma'_i)^{-1}).
 \end{aligned}$$

Thus, either the tuples $(\sigma_1, \sigma_2, \dots, \sigma_d)$ and $(\sigma'_1, \sigma'_2, \dots, \sigma'_d)$ define equivalent graphs $G_{\sigma_1, \sigma_2, \dots, \sigma_d}$ and $G_{\sigma'_1, \sigma'_2, \dots, \sigma'_d}$, respectively, or the result is 0. This precisely tells us that the graph base forms an orthogonal system. The above computes further using the order of the automorphism group of the graph

$$\begin{aligned}
 (39) \quad &\delta\left(\sum_{\gamma_i, \gamma} \otimes_i^d \gamma_i \sigma_i \gamma; \sum_{\tau_i, \tau} \otimes_i^d \tau_i \sigma'_i \tau\right) \\
 &= [(2n)!(n!2^n)] \delta(G_{\sigma_1, \sigma_2, \dots, \sigma_d}; G_{\sigma'_1, \sigma'_2, \dots, \sigma'_d}) \text{Aut}(G_{\sigma_1, \sigma_2, \dots, \sigma_d}).
 \end{aligned}$$

Therefore, there exists a non degenerate bilinear pairing on $\mathcal{K}_d(2n)$ and the following holds:

Theorem 4.2. $\mathcal{K}_d(2n)$ is an associative unital semi-simple algebra.

As a corollary of Theorem 4.2, the Wedderburn-Artin theorem guarantees that $\mathcal{K}_d(2n)$ decomposes in matrix subalgebras. It might be interesting to investigate a base of such a decomposition of $\mathcal{K}_d(2n)$ in irreducible matrix subalgebras. One could be tempted to think that, at $d = 3$, restricting to $\mathcal{K}_3(2n)$, the Kronecker coefficients for even partitions could be themselves squares, and therefore define the dimensions of the irreducible subalgebras. This is not the case as this can be easily shown using the same Sage code

given in Appendix B (by printing the Kronecker). This point is postponed for future investigations. In the mean time, it is legitimate to ask a representation base with labels that reflect the dimension (30). This is the purpose of the next paragraph.

Constructing a representation theoretic base Q of $\mathcal{K}_3(2n)$ - Let us introduce the representation base of $\mathbb{C}[S_{2n}]$ given by the elements

$$(40) \quad Q_{ij}^R = \frac{\kappa_R}{(2n)!} \sum_{\sigma \in S_{2n}} D_{ij}^R(\sigma)\sigma, \quad \text{with } \kappa_R^2 = (2n)!d(R),$$

that obey the orthogonality relation $\delta(Q_{ij}^R; Q_{i'j'}^{R'}) = \delta_{RR'}\delta_{ii'}\delta_{jj'}$. The base $\{Q_{ij}^R\}$ counts $\sum_{R \vdash 2n} (d(R))^2 = (2n)!$ elements and forms the Fourier theoretic base of $\mathbb{C}[S_{2n}]$. Appendix A.3 collects a few other properties of this base for a general permutation group.

We fix $d = 3$ and build now the invariant representation theoretic (Fourier for short) base of the algebra $\mathcal{K}_3(2n)$ (35). Consider the right diagonal action $\rho_R(\cdot)$ and the three left actions $\varrho_i(\cdot)$ on the tensor product $\mathbb{C}[S_{2n}]^{\otimes 3}$. Then we write:

$$(41) \quad \begin{aligned} & \sum_{\gamma_1, \gamma_2, \gamma_3 \in S_n} \sum_{\gamma \in S_{2n}} \varrho_1(\gamma_1)\varrho_2(\gamma_2)\varrho_3(\gamma_3)\rho_R(\gamma) Q_{i_1j_1}^{R_1} \otimes Q_{i_2j_2}^{R_2} \otimes Q_{i_3j_3}^{R_3} \\ &= \sum_{\gamma_\alpha} \sum_{\gamma} \gamma_1 Q_{i_1j_1}^{R_1} \gamma \otimes \gamma_2 Q_{i_2j_2}^{R_2} \gamma \otimes \gamma_3 Q_{i_3j_3}^{R_3} \gamma \\ &= \sum_{\gamma_\alpha} \sum_{\gamma} \sum_{p_l, q_l} D_{p_1i_1}^{R_1}(\gamma_1) Q_{p_1q_1}^{R_1} D_{j_1q_1}^{R_1}(\gamma) \\ & \quad \otimes D_{p_2i_2}^{R_2}(\gamma_2) Q_{p_2q_2}^{R_2} D_{j_2q_2}^{R_2}(\gamma) \otimes D_{p_3i_3}^{R_3}(\gamma_3) Q_{p_3q_3}^{R_3} D_{j_3q_3}^{R_3}(\gamma) \\ &= \frac{(2n)!}{d(R_3)} \sum_{\gamma_\alpha} \sum_{p_l, q_l} \sum_{\tau} C_{j_1, j_2; j_3}^{R_1, R_2; R_3, \tau} C_{q_1, q_2; q_3}^{R_1, R_2; R_3, \tau} \\ & \quad \times D_{p_1i_1}^{R_1}(\gamma_1) D_{p_2i_2}^{R_2}(\gamma_2) D_{p_3i_3}^{R_3}(\gamma_3) Q_{p_1q_1}^{R_1} \otimes Q_{p_2q_2}^{R_2} \otimes Q_{p_3q_3}^{R_3}. \end{aligned}$$

We used (A.20) to multiply group elements with the Q base, see Appendix A.3; then use (A.16) to sum over γ the 3 representation matrices, see in Appendix A.2.

We couple this last result with a Clebsch-Gordan coefficient, in order to get, using (A.14):

$$\begin{aligned}
 (42) \quad & \sum_{j_i} C_{j_1, j_2; j_3}^{R_1, R_2; R_3, \tau} \sum_{\gamma_a} \sum_{\gamma} \varrho_1(\gamma_1) \varrho_2(\gamma_2) \varrho_3(\gamma_3) \rho_R(\gamma) Q_{i_1 j_1}^{R_1} \otimes Q_{i_2 j_2}^{R_2} \otimes Q_{i_3 j_3}^{R_3} \\
 &= (2n)! \sum_{p_i, q_i} C_{q_1, q_2; q_3}^{R_1, R_2; R_3, \tau} \sum_{\gamma_1} D_{p_1 i_1}^{R_1}(\gamma_1) \sum_{\gamma_2} D_{p_2 i_2}^{R_2}(\gamma_2) \sum_{\gamma_3} D_{p_3 i_3}^{R_3}(\gamma_3) \\
 &\quad \times Q_{p_1 q_1}^{R_1} \otimes Q_{p_2 q_2}^{R_2} \otimes Q_{p_3 q_3}^{R_3}.
 \end{aligned}$$

Once again, we should stress the fact that $\sum_{\gamma \in S_n[S_2]} D_{pq}^R(\gamma) \neq 0$, if and only if R is a partition of $2n$ with even rows. This condition will be always assumed in the next calculations. Now, we can split the Wigner matrix element using branching coefficients of $S_n[S_2]$ in S_{2n} . Consider V^R a irreps S_{2n} (see Appendix A listing a few basic facts on representation theory of S_n and our notations), and the subgroup inclusion $S_n[S_2] \subset S_{2n}$, we can decompose V^R in irreps V^r of $S_n[S_2]$ as

$$(43) \quad V^R = \bigoplus_r V^r \otimes V_{R,r}$$

where $V_{R,r}$ is a vector space of dimension the multiplicity of the irreps r in R . A state in this decomposition denotes $|r, m_r, \nu_r\rangle$, where m_r labels the states of V^r and $\nu_r = 1, \dots, \dim V_{R,r}$.

The branching coefficients that are of interest are the coefficients of $|r, m_r, \nu_r\rangle$ when decomposed in an orthonormal base of the irreps R :

$$(44) \quad B_{i; m_r}^{R; r, \nu_r} = \langle R, i | r, m_r, \nu_r \rangle = \langle r, m_r, \nu_r | R, i \rangle.$$

The last relation is deduced from the fact that we use real representations. Using the decomposition of the identity, the branching coefficients satisfy the following identities

$$(45) \quad \sum_i B_{i; m_r}^{R; r, \nu_r} B_{i; m_s}^{R; s, \nu_s} = \delta_{rs} \delta_{\nu_r \nu_s} \delta_{m_r m_s}$$

$$(46) \quad \sum_{r, m_r, \nu_r} B_{i; m_r}^{R; r, \nu_r} B_{i'; m_r}^{R'; r, \nu_r} = \delta_{RR'} \delta_{ii'}.$$

We have the following useful relation, for $\sigma \in S_n[S_2]$,

$$(47) \quad \sum_j D_{ij}^R(\sigma) B_{j; m_r}^{R; r, \nu_r} = \sum_{m'_r} D_{m_r m'_r}^r(\sigma) B_{i; m'_r}^{R; r, \nu_r},$$

where $D_{m_r, m_r}^r(\sigma)$ is the representation matrix of σ as an element of $S_n[S_2]$. Restricting this to $r = \overline{[2n]}$, the trivial representation of $S_n[S_2]$ that is one dimensional and with multiplicity always 1 for all R , we obtain:

$$(48) \quad \sum_j D_{ij}^R(\sigma) B_{j;1}^{R; \overline{[2n]}, 1} = D_{11}^{\overline{[2n]}}(\sigma) B_{i;1}^{R; \overline{[2n]}, 1} = B_{i;1}^{R; \overline{[2n]}, 1}.$$

We now treat the sum over the representation matrices in (42). Inserting twice a complete set of states therein, we get

$$(49) \quad \sum_{\sigma \in S_n[S_2]} D_{ij}^R(\sigma) = \sum_{\sigma \in S_n[S_2]} \sum_{r, \nu_r, m_r; s, \nu_s, m_s} B_{i; m_r}^{R; r, \nu_r} B_{j; m_s}^{R; s, \nu_s} \langle r, \nu_r, m_r | \sigma | s, \nu_s, m_s \rangle.$$

Noting that $\sum_{s \in S_n[S_2]} \sigma = \sum_{s \in S_n[S_2]} \sigma \chi^{\overline{[2n]}}(\sigma)$ is, up to the factor $1/[n!2^n]$, nothing but the projector onto the trivial $\overline{[2n]}$ representation of $S_n[S_2]$, the overlap computes to

$$(50) \quad \sum_{\sigma \in S_n[S_2]} \langle r, \nu_r, m_r | \sigma | s, \nu_s, m_s \rangle = (2^n n!) \delta_{r, \overline{[2n]}} \delta_{s, \overline{[2n]}} \delta_{1m_r} \delta_{1m_s} \delta_{1\nu_s} \delta_{1\nu_r},$$

since we have

$$(51) \quad \begin{aligned} \sum_{\sigma \in S_n[S_2]} \sigma |s, \nu_s, m_s\rangle &= \sum_{\sigma \in S_n[S_2]} \chi^{\overline{[2n]}}(\sigma) \sum_k D_{m_s k}^s(\sigma) |s, \nu_s, k\rangle \\ &= \sum_{\sigma \in S_n[S_2]} D_{11}^{\overline{[2n]}}(\sigma) \sum_k D_{m_s k}^s(\sigma) |s, \nu_s, k\rangle \\ &= \frac{2^n n!}{d(\overline{[2n]})} \sum_k \delta_{\overline{[2n]}, s} \delta_{1m_s} \delta_{1\nu_s} \delta_{1k} |s, \nu_s, k\rangle \\ &= (2^n n!) \delta_{\overline{[2n]}, s} \delta_{1m_s} \delta_{1\nu_s} | \overline{[2n]}, 1, 1 \rangle. \end{aligned}$$

Hence,

$$(52) \quad \sum_{\sigma \in S_n[S_2]} D_{ij}^R(\sigma) = (2^n n!) B_i^{R; tr} B_j^{R; tr},$$

where we have defined $B_i^{R; tr} = \langle R, i | \overline{[2n]}, 1, 1 \rangle$.

From the above calculation, we finally get from (42):

$$\begin{aligned}
 (53) \quad & \sum_{j_i} C_{j_1, j_2; j_3}^{R_1, R_2; R_3, \tau} \sum_{\gamma_a} \sum_{\gamma} \varrho_1(\gamma_1) \varrho_2(\gamma_2) \varrho_3(\gamma_3) \rho_R(\gamma) Q_{i_1 j_1}^{R_1} \otimes Q_{i_2 j_2}^{R_2} \otimes Q_{i_3 j_3}^{R_3} \\
 & = (2n)!(n!2^n)^3 B_{i_1}^{R_1; tr} B_{i_2}^{R_2; tr} B_{i_3}^{R_3; tr} \\
 & \quad \times \sum_{p_i, q_i} C_{q_1, q_2; q_3}^{R_1, R_2; R_3, \tau} B_{p_1}^{R_1; tr} B_{p_2}^{R_2; tr} B_{p_3}^{R_3; tr} Q_{p_1 q_1}^{R_1} \otimes Q_{p_2 q_2}^{R_2} \otimes Q_{p_3 q_3}^{R_3}
 \end{aligned}$$

We now define an element

$$\begin{aligned}
 Q^{R_1, R_2, R_3, \tau} & = \kappa_{\vec{R}} \sum_{p_i, q_i} C_{q_1, q_2; q_3}^{R_1, R_2; R_3, \tau} B_{p_1}^{R_1; tr} B_{p_2}^{R_2; tr} B_{p_3}^{R_3; tr} Q_{p_1 q_1}^{R_1} \otimes Q_{p_2 q_2}^{R_2} \otimes Q_{p_3 q_3}^{R_3} \\
 & = \kappa_{\vec{R}} \frac{\kappa_{R_1} \kappa_{R_2} \kappa_{R_3}}{((2n)!)^3} \\
 (54) \quad & \quad \times \sum_{\sigma_i} \sum_{p_i, q_i} C_{q_1, q_2; q_3}^{R_1, R_2; R_3, \tau} \left[\prod_{i=1}^3 B_{p_i}^{R_i; tr} D_{p_i q_i}^{R_i}(\sigma_i) \right] \sigma_1 \otimes \sigma_2 \otimes \sigma_3
 \end{aligned}$$

where $\kappa_{\vec{R}}$ is a normalization constant to be fixed later and the notation \vec{R} stands for (R_1, R_2, R_3) . The set $\{Q^{R_1, R_2, R_3, \tau}\}$ is of cardinality the counting of orthogonal invariants given by (30).

Invariance - Let us check that the element $Q^{R_1, R_2, R_3, \tau}$ is invariant under left multiplication on each factor and diagonal right multiplication:

$$\begin{aligned}
 (55) \quad & (\gamma_1 \otimes \gamma_2 \otimes \gamma_3) Q^{R_1, R_2, R_3, \tau} (\gamma \otimes \gamma \otimes \gamma) \\
 & = \kappa_{\vec{R}} \sum_{p_i, q_i} C_{q_1, q_2; q_3}^{R_1, R_2; R_3, \tau} B_{p_1}^{R_1; tr} B_{p_2}^{R_2; tr} B_{p_3}^{R_3; tr} \sum_{\ell_1, j_1} D_{\ell_1 p_1}^{R_1}(\gamma_1) Q_{\ell_1 j_1}^{R_1} D_{q_1 j_1}^{R_1}(\gamma) \\
 & \quad \otimes \sum_{\ell_2, j_2} D_{\ell_2 p_2}^{R_2}(\gamma_2) Q_{\ell_2 j_2}^{R_2} D_{q_2 j_2}^{R_2}(\gamma) \otimes \sum_{\ell_3, j_3} D_{\ell_3 p_3}^{R_3}(\gamma_3) Q_{\ell_3 j_3}^{R_3} D_{q_3 j_3}^{R_3}(\gamma) \\
 & = \kappa_{\vec{R}} \sum_{j_i} C_{j_1, j_2; j_3}^{R_1, R_2; R_3, \tau} \sum_{p_i, \ell_i} D_{\ell_1 p_1}^{R_1}(\gamma_1) B_{p_1}^{R_1; tr} D_{\ell_2 p_2}^{R_2}(\gamma_2) B_{p_2}^{R_2; tr} \\
 & \quad \times D_{\ell_3 p_3}^{R_3}(\gamma_3) B_{p_3}^{R_3; tr} Q_{\ell_1 j_1}^{R_1} \otimes Q_{\ell_2 j_2}^{R_2} \otimes Q_{\ell_3 j_3}^{R_3} \\
 & = \kappa_{\vec{R}} \sum_{j_i, \ell_i} C_{j_1, j_2; j_3}^{R_1, R_2; R_3, \tau} B_{\ell_1}^{R_1; tr} B_{\ell_2}^{R_2; tr} B_{\ell_3}^{R_3; tr} Q_{\ell_1 j_1}^{R_1} \otimes Q_{\ell_2 j_2}^{R_2} \otimes Q_{\ell_3 j_3}^{R_3} \\
 & = Q^{R_1, R_2, R_3, \tau},
 \end{aligned}$$

where we used once again (A.20) and (A.14) at intermediate step and the identity (48) to get the last line.

We check a few properties of the product of elements of $\mathcal{K}_3(2n)$.

Product - The elements (40) of the Fourier base of $\mathbb{C}[S_{2n}]$ multiply as follows (see Appendix A.3.)

$$(56) \quad Q_{ij}^R Q_{kl}^{R'} = \frac{\kappa_R}{d(R)} \delta_{RR'} \delta_{jk} Q_{il}^{R'}.$$

The definition (54) and relation (56) allow us to compute the product

$$(57) \quad \begin{aligned} & Q^{R_1, R_2, R_3, \tau} Q^{R'_1, R'_2, R'_3, \tau'} \\ &= \frac{\kappa_{\vec{R}} \kappa_{\vec{R}'} \kappa_{R_1} \kappa_{R_2} \kappa_{R_3}}{d(R_1) d(R_2) d(R_3)} \delta_{\vec{R} \vec{R}'} \sum_{\substack{p_1 \ q_1 \ a_1 \ b_1 \\ p_2 \ q_2 \ a_2 \ b_2 \\ p_3 \ q_3 \ a_3 \ b_3}} C_{q_1, q_2; q_3}^{R_1, R_2; R_3, \tau} C_{b_1, b_2; b_3}^{R'_1, R'_2; R'_3, \tau'} \\ &\quad \times B_{p_1}^{R_1; tr} B_{p_2}^{R_2; tr} B_{p_3}^{R_3; tr} B_{a_1}^{R'_1; tr} B_{a_2}^{R'_2; tr} B_{a_3}^{R'_3; tr} \\ &\quad \times Q_{p_1 b_1}^{R'_1} \otimes Q_{p_2 b_2}^{R'_2} \otimes Q_{p_3 b_3}^{R'_3} \delta_{q_1 a_1} \delta_{q_2 a_2} \delta_{q_3 a_3} \\ &= \frac{\kappa_{\vec{R}} \kappa_{R_1} \kappa_{R_2} \kappa_{R_3}}{d(R_1) d(R_2) d(R_3)} \delta_{\vec{R} \vec{R}'} \\ &\quad \times \left[\sum_{q_i} C_{q_1, q_2; q_3}^{R'_1, R'_2; R'_3, \tau} B_{q_1}^{R'_1; tr} B_{q_2}^{R'_2; tr} B_{q_3}^{R'_3; tr} \right] Q^{R'_1, R'_2, R'_3, \tau'}. \end{aligned}$$

Hence, the product of two base elements expands in terms of $Q^{R_1, R_2, R_3, \tau}$. In a compact notation, we write

$$(58) \quad Q^{R_1, R_2, R_3, \tau} Q^{R'_1, R'_2, R'_3, \tau'} = \delta_{\vec{R} \vec{R}'} k(\vec{R}', \tau) Q^{R'_1, R'_2, R'_3, \tau'}$$

which shows that the product is almost orthogonal. Still it cannot represent the base of Wedderburn-Artin matrix decomposition. The base $\{Q^{R_1, R_2, R_3, \tau}\}$ therefore decomposes $\mathcal{K}_3(2n)$ in blocks mutually orthogonal in the labels R_1, R_2, R_3 . Still in each block the decomposition remains unachieved.

Associativity - We check the associativity of the product in the Q -base. On the one hand, we have

$$(59) \quad \begin{aligned} & \left(Q^{R_1, R_2, R_3, \tau} Q^{R'_1, R'_2, R'_3, \tau'} \right) Q^{R''_1, R''_2, R''_3, \tau''} \\ &= \frac{\kappa_{\vec{R}} \kappa_{R_1} \kappa_{R_2} \kappa_{R_3}}{d(R_1) d(R_2) d(R_3)} \delta_{\vec{R} \vec{R}'} \left[\sum_{q_i} C_{q_1, q_2; q_3}^{R'_1, R'_2; R'_3, \tau} B_{q_1}^{R'_1; tr} B_{q_2}^{R'_2; tr} B_{q_3}^{R'_3; tr} \right] \\ &\quad \times \frac{\kappa_{\vec{R}'} \kappa_{R'_1} \kappa_{R'_2} \kappa_{R'_3}}{d(R'_1) d(R'_2) d(R'_3)} \delta_{\vec{R}' \vec{R}''} \left[\sum_{q_i} C_{q_1, q_2; q_3}^{R''_1, R''_2; R''_3, \tau'} B_{q_1}^{R''_1; tr} B_{q_2}^{R''_2; tr} B_{q_3}^{R''_3; tr} \right] \\ &\quad \times Q^{R''_1, R''_2, R''_3, \tau''} \end{aligned}$$

and on the other,

$$\begin{aligned}
 (60) \quad & Q^{R_1, R_2, R_3, \tau} \left(Q^{R'_1, R'_2, R'_3, \tau'} Q^{R''_1, R''_2, R''_3, \tau''} \right) \\
 &= \frac{\kappa_{\vec{R}'} \kappa_{R'_1} \kappa_{R'_2} \kappa_{R'_3}}{d(R'_1) d(R'_2) d(R'_3)} \delta_{\vec{R}' \vec{R}''} \left[\sum_{q_i} C_{q_1, q_2; q_3}^{R'_1, R'_2; R'_3, \tau'} B_{q_1}^{R''_1; tr} B_{q_2}^{R''_2; tr} B_{q_3}^{R''_3; tr} \right] \\
 &\quad \times \frac{\kappa_{\vec{R}} \kappa_{R_1} \kappa_{R_2} \kappa_{R_3}}{d(R_1) d(R_2) d(R_3)} \delta_{\vec{R} \vec{R}''} \left[\sum_{q_i} C_{q_1, q_2; q_3}^{R''_1, R''_2; R''_3, \tau} B_{q_1}^{R'_1; tr} B_{q_2}^{R'_2; tr} B_{q_3}^{R'_3; tr} \right] \\
 &\quad \times Q^{R''_1, R''_2, R''_3, \tau''}.
 \end{aligned}$$

The two expressions are identical.

Pairing - We use the pairing on $\mathbb{C}[S_{2n}]^{\otimes 3}$ along the lines (A.24) and evaluate:

$$\begin{aligned}
 (61) \quad & \delta(Q^{R_1, R_2, R_3, \tau}; Q^{R'_1, R'_2, R'_3, \tau'}) \\
 &= \kappa_{\vec{R}} \kappa_{\vec{R}'} \sum_{p_i q_i a_i b_i} C_{q_1, q_2; q_3}^{R_1, R_2; R_3, \tau} C_{b_1, b_2; b_3}^{R'_1, R'_2; R'_3, \tau'} \\
 &\quad \times B_{p_1}^{R_1; tr} B_{p_2}^{R_2; tr} B_{p_3}^{R_3; tr} B_{a_1}^{R'_1; tr} B_{a_2}^{R'_2; tr} B_{a_3}^{R'_3; tr} \\
 &\quad \times \delta(Q_{p_1 q_1}^{R_1} \otimes Q_{p_2 q_2}^{R_2} \otimes Q_{p_3 q_3}^{R_3}; Q_{a_1 b_1}^{R'_1} \otimes Q_{a_2 b_2}^{R'_2} \otimes Q_{a_3 b_3}^{R'_3}) \\
 &= \kappa_{\vec{R}} \kappa_{\vec{R}'} \sum_{p_i q_i a_i b_i} C_{q_1, q_2; q_3}^{R_1, R_2; R_3, \tau} C_{b_1, b_2; b_3}^{R'_1, R'_2; R'_3, \tau'} \\
 &\quad \times B_{p_1}^{R_1; tr} B_{p_2}^{R_2; tr} B_{p_3}^{R_3; tr} B_{a_1}^{R'_1; tr} B_{a_2}^{R'_2; tr} B_{a_3}^{R'_3; tr} \\
 &\quad \times \delta_{\vec{R} \vec{R}'} \delta_{p_1 a_1} \delta_{p_2 a_2} \delta_{p_3 a_3} \delta_{q_1 b_1} \delta_{q_2 b_2} \delta_{q_3 b_3} \\
 &= \kappa_{\vec{R}}^2 d(R_3) \sum_{p_i} \left[\prod_{i=1}^3 B_{p_i}^{R_i; tr} \right]^2 \delta_{\vec{R} \vec{R}'} \delta_{\tau \tau'} = \kappa_{\vec{R}}^2 d(R_3) \delta_{\vec{R} \vec{R}'} \delta_{\tau \tau'}
 \end{aligned}$$

where, in the first line, we used (A.24), in the last, (A.11), and the fact that, by (45), the following holds

$$\sum_p [B_p^{R; tr}]^2 = \sum_p \langle [2n], 1, 1 | R, p \rangle \langle R, p | [2n], 1, 1 \rangle = 1,$$

for all $R \vdash 2n$. We could therefore fix the normalization $\kappa_{\vec{R}}^2 = 1/d(R_3)$.

The following statement holds:

Proposition 4.3. $\{Q^{R_1, R_2, R_3, \tau}\}$ is an invariant orthonormal base of $\mathcal{K}_3(2n)$.

Proof. It is sufficient to show that the graph base expands in terms of the Q -base. We hold the non degenerate pairing δ and express any graph base element $G_{\sigma_1, \sigma_2, \sigma_3} = \sum_{\gamma_i \in S_n[S_2]} \sum_{\gamma \in S_{2n}} \gamma_1 \sigma_1 \gamma \otimes \gamma_2 \sigma_2 \gamma \otimes \gamma_3 \sigma_3 \gamma$ as

$$(62) \quad G_{\sigma_1, \sigma_2, \sigma_3} = \sum_{R_i, \tau} \delta(Q^{R_1, R_2, R_3, \tau}; G_{\sigma_1, \sigma_2, \sigma_3}) Q^{R_1, R_2, R_3, \tau}$$

The definition of $Q^{R_1, R_2, R_3, \tau}$ calls a linear combination of triples $(\tau_1 \otimes \tau_2 \otimes \tau_3)$ that must have a non trivial overlap with $G_{\sigma_1, \sigma_2, \sigma_3}$. Let us compute the overlap between the bases. Start with (54) and then write (using (A.14) and then (48))

$$(63) \quad \delta(Q^{R_1, R_2, R_3, \tau}; G_{\sigma_1, \sigma_2, \sigma_3}) = \kappa_{\vec{R}} \frac{\kappa_{R_1} \kappa_{R_2} \kappa_{R_3}}{((2n)!)^3} ((2^n n!)^3 (2n!)) \\ \times \sum_{a_i, b_i} C_{b_1, b_2; b_3}^{R_1, R_2; R_3, \tau} \left[\prod_{i=1}^3 B_{a_i}^{R_i; tr} D_{a_i, b_i}^{R_i}(\sigma_i) \right].$$

This number is, up to the normalization $((2^n n!)^3 (2n!))$, the coefficient of the triple $(\sigma_1 \otimes \sigma_2 \otimes \sigma_3)$ in $Q^{R_1, R_2, R_3, \tau}$. □

We note that the base $\{Q^{R_1, R_2, R_3, \tau}\}$ is of the correct cardinality, that of $Z_3(2n)$ as we sought.

Finding of the Wedderburn-Artin matrix base of $\mathcal{K}_3(2n)$ means that $Z_3(2n)$ can be written as a sum of squares. Interestingly, within the TFT₂ formulation of the counting, we note that the partition function (23) computes further using (A.4) as

$$(64) \quad Z_3(2n) = \frac{1}{[n!(2!)^n]^3} \sum_{R_i \vdash 2n} \left(\sum_{\gamma_1} \chi^{R_1}(\gamma_1) \right) \\ \times \left(\sum_{\gamma_2} \chi^{R_2}(\gamma_2) \right) \left(\sum_{\gamma_3} \chi^{R_1}(\gamma_3) \chi^{R_2}(\gamma_3) \right) \\ = \frac{1}{n!(2!)^n} \sum_{R_i \vdash 2n / R_i \text{ even}} \sum_{\gamma_3} \chi^{R_1}(\gamma_3) \chi^{R_2}(\gamma_3) \\ = \frac{1}{n!(2!)^n} \sum_{\gamma_3} \left(\sum_{R \vdash 2n / R \text{ even}} \chi^R(\gamma_3) \right)^2,$$

thus, as a normalized sum of squares. This shows that $Z_3(2n)$ could admit several decompositions in squares. If $\left(\sum_{R \vdash 2n / R \text{ even}} \chi^R(\gamma_3) \right)^2$ is the

dimension of a subalgebra (given that the characters are integers via the Murnaghan-Kakayama rule), this would mean that this decomposition in sub-algebras would be labeled by γ_3 and will be even different from the Wedderburn-Artin decomposition. This decomposition deserves further clarification in the present $O(N)$ setting.

About projectors – Let us define the normalized projectors as

$$(65) \quad P_1^{S_n[S_2]} P_2^{S_n[S_2]} P_3^{S_n[S_2]} P_R^{S_{2n}} = \frac{1}{[n!(2!)^n]^3(2n)!} \times \sum_{\gamma_l \in S_n[S_2]} \sum_{\gamma \in S_{2n}} \varrho_1(\gamma_1)\varrho_2(\gamma_2)\varrho_3(\gamma_3)\rho_R(\gamma),$$

and check that the trace of their product yields the dimension of the algebra $\mathcal{K}_3(2n)$:

$$(66) \quad \dim \mathcal{K}_3(2n) = \text{tr}_{\mathbb{C}[S_{2n}]^{\otimes 3}}(P_1^{S_n[S_2]} P_2^{S_n[S_2]} P_3^{S_n[S_2]} P_R^{S_{2n}}) = \text{tr}_{\mathcal{K}_3(2n)}(\mathbf{1}).$$

We have

$$(67) \quad \sum_{\gamma_a \in S_n[S_2]} \sum_{\gamma \in S_{2n}} \varrho_1(\gamma_1)\varrho_2(\gamma_2)\varrho_3(\gamma_3)\rho_R(\gamma) Q_{i_1 j_1}^{R_1} \otimes Q_{i_2 j_2}^{R_2} \otimes Q_{i_3 j_3}^{R_3} \\ = \sum_{\gamma_a} \sum_{\gamma} \sum_{p_l q_l} D_{p_1 i_1}^{R_1}(\gamma_1) D_{j_1 q_1}^{R_1}(\gamma) D_{p_2 i_2}^{R_2}(\gamma_2) D_{j_2 q_2}^{R_2}(\gamma) D_{p_3 i_3}^{R_3}(\gamma_3) D_{j_3 q_3}^{R_3}(\gamma) \\ \times Q_{p_1 q_1}^{R_1} \otimes Q_{p_2 q_2}^{R_2} \otimes Q_{p_3 q_3}^{R_3}.$$

To compute the trace, pair this with $Q_{i_1 j_1}^{R_1} \otimes Q_{i_2 j_2}^{R_2} \otimes Q_{i_3 j_3}^{R_3}$ using the orthonormality property $\delta(Q_{ij}^R; Q_{kl}^S) = \delta_{RS}\delta_{ik}\delta_{jl}$ and sum over R_l, i_l, j_l yielding

$$(68) \quad \sum_{R_l \vdash S_{2n}} \sum_{\gamma_a} \sum_{\gamma} \sum_{p_l q_l, i_l, j_l} D_{p_1 i_1}^{R_1}(\gamma_1) D_{j_1 q_1}^{R_1}(\gamma) D_{p_2 i_2}^{R_2}(\gamma_2) D_{j_2 q_2}^{R_2}(\gamma) \\ \times D_{p_3 i_3}^{R_3}(\gamma_3) D_{j_3 q_3}^{R_3}(\gamma) \delta_{i_1 p_1} \delta_{j_1 q_1} \delta_{i_2 p_2} \delta_{j_2 q_2} \delta_{i_3 p_3} \delta_{j_3 q_3} \\ = \sum_{R_l \vdash S_{2n}} \sum_{\gamma_a} \sum_{\gamma} \sum_{i_l, j_l} D_{i_1 i_1}^{R_1}(\gamma_1) D_{j_1 j_1}^{R_1}(\gamma) D_{i_2 i_2}^{R_2}(\gamma_2) \\ \times D_{j_2 j_2}^{R_2}(\gamma) D_{i_3 i_3}^{R_3}(\gamma_3) D_{j_3 j_3}^{R_3}(\gamma) \\ = (2n)! \sum_{R_l \vdash S_{2n}} \sum_{\gamma_a} \mathbf{C}(R_1, R_2, R_3) \chi^{R_1}(\gamma_1) \chi^{R_2}(\gamma_2) \chi^{R_3}(\gamma_3).$$

Hence we find (27) using Burnside’s lemma, and we have $Z_3(n) = \dim \mathcal{K}_3(2n)$.

5. Correlators

Let us analyze Gaussian correlators, starting with $d = 3$ and then extending it at any d . We consider the normal ordered correlator of two observables $O_b(T)O_{b'}(T)$ in the Gaussian measure $d\nu(T)$ (3). Normal order means that we only allow contraction from $O_b(T)$ to $O_{b'}(T)$.

Rank $d = 3$ correlator - Before computing the correlators, a few remarks must be done. A 3-tuple of permutations labels the observables: $O_b(T) = O_{\sigma_1, \sigma_2, \sigma_3}(T)$ and $O_{b'}(T) = O_{\tau_1, \tau_2, \tau_3}(T)$. Recall that an observable $O_{\sigma_1, \sigma_2, \sigma_3}(T)$ is in fact defined by a contraction of tensor indices. This contraction pattern, that gives in return the color edges of the graph associated with the observable, is not defined by the triple $(\sigma_1, \sigma_2, \sigma_3)$ but by the following triple

$$(69) \quad (\tilde{\sigma}_1, \tilde{\sigma}_2, \tilde{\sigma}_3) = (\sigma_1^{-1}\xi\sigma_1, \sigma_2^{-1}\xi\sigma_2, \sigma_3^{-1}\xi\sigma_3),$$

where we recall that ξ is the fixed permutation (12)(34) . . . (2n - 1, 2n). The justification of this is immediate: each swop in ξ corresponds to a label of the half-lines of the vertex v_j^i , see Figure 1. Consider the l -th edge of color i from the l -th tensor. The vertex links v_j^i the image of $\sigma_i(l)$ and the pre-image through σ_i of $\xi(\sigma_i(l))$. We need the following convenient notation for tensors: $T_{a_{i1}a_{i2}a_{i3}}$, the index $i = 1, \dots, 2n$ stands for the label of the tensor which at the end will not matter in the definition of the observable. Using this, an observable made of the contraction of $2n$ tensors can be expressed as:

$$(70) \quad O_{\sigma_1, \sigma_2, \sigma_3}(T) = \sum_{a_{ij}} \prod_{i=1}^{2n} \prod_{j=1}^3 \delta_{a_{\tilde{\sigma}_j(i)}j}^{a_{ij}} \prod_{i=1}^{2n} T_{a_{i1}a_{i2}a_{i3}}$$

where $a_{ij} = 1, \dots, N$. There are many redundant Kroneckers δ in the previous expression. However, the calculus here is discrete and so there are no particular issues. When we will compute the correlator using the Wick theorem, it is the triple $(\tilde{\sigma}_1, \tilde{\sigma}_2, \tilde{\sigma}_3)$ that is concerned.

The Wick contraction between two observables, in the normal order, introduces a permutation $\mu \in S_{2n}$. A correlator simply counts cycles of a convolution of permutations. Let us determine which convolution is that, using twice (70) and the free propagator (4):

$$\begin{aligned}
 \langle O_{\sigma_1, \sigma_2, \sigma_3}(T) O_{\tau_1, \tau_2, \tau_3}(T) \rangle &= \frac{1}{\int d\nu(T)} \int d\nu(T) O_{\sigma_1, \sigma_2, \sigma_3}(T) O_{\tau_1, \tau_2, \tau_3}(T) \\
 (71) \qquad &= \sum_{\mu} \sum_{a_{ij}, b_{kl}} \left[\prod_{i=1}^{2n} \prod_{j=1}^3 \delta_{a_{\tilde{\sigma}_j(i)j}}^{a_{ij}} \delta_{b_{\tilde{\tau}_j(i)j}}^{b_{ij}} \right] \left[\prod_{i=1}^{2n} \prod_{j=1}^3 \delta_{b_{\mu(i)j}}^{a_{ij}} \right].
 \end{aligned}$$

Summing over the b_l variables and using a change of variable, $b_{ij} = a_{\mu^{-1}(i)j}$, lead us to

$$\begin{aligned}
 (72) \quad \langle O_{\sigma_1, \sigma_2, \sigma_3}(T) O_{\tau_1, \tau_2, \tau_3}(T) \rangle &= \sum_{\mu} \sum_{a_{ij}} \left[\prod_{i=1}^{2n} \prod_{j=1}^3 \delta_{a_{\tilde{\sigma}_j(i)j}}^{a_{ij}} \delta_{a_{\mu^{-1}\tilde{\tau}_j(i)j}}^{a_{\mu^{-1}(i)j}} \right] \\
 &= \sum_{\mu} \sum_{a_{ij}} \left[\prod_{i=1}^{2n} \prod_{j=1}^3 \delta_{a_{\tilde{\sigma}_j(i)j}}^{a_{ij}} \delta_{a_{\mu^{-1}\tilde{\tau}_j\mu(i)j}}^{a_{ij}} \right] \\
 &= \sum_{\mu} \sum_{a_{ij}} \left[\prod_{i=1}^{2n} \prod_{j=1}^3 \delta_{a_{\tilde{\sigma}_j(i)j}}^{a_{ij}} \delta_{a_{\mu^{-1}\tilde{\tau}_j\mu\tilde{\sigma}(i)j}}^{a_{ij}} \right],
 \end{aligned}$$

where we also used $\tilde{\sigma}_j^{-1} = \tilde{\sigma}_j$. We already guess that the correlator expresses as a power of N in a number of cycles of $\mu^{-1}\tilde{\tau}_j\mu\tilde{\sigma}_j$. However, the proof is not obvious because of the redundancy of the δ introduced in the definition of the observable, see (70).

The following statement holds

Lemma 5.1. *Let a_i be an integer, $a_i = 1, \dots, N$, for $i = 1, \dots, 2n$. Then, (at fixed color j that we will omit in the ensuing notation)*

$$(73) \quad \sum_{a_i} \left[\prod_{i=1}^{2n} \delta_{a_{\tilde{\sigma}(i)}}^{a_i} \delta_{a_{\mu^{-1}\tilde{\tau}_j\mu\tilde{\sigma}(i)}}^{a_i} \right] = N^{\mathbf{c}(\mu^{-1}\tilde{\tau}_j\mu\tilde{\sigma})},$$

where $\mathbf{c}(\sigma)$ is the number of cycles of the permutation σ .

Proof. The sole issue here is the redundancy of the Kronecker’s. In fact, there is enough information in the above sum to withdraw the correct number of cycles. Call “vertex δ ’s” those appearing in the product $\prod_{i=1}^{2n} \delta_{a_{\tilde{\sigma}(i)}}^{a_i}$, and (Wick) “contraction δ ’s” the remaining ones coming from the resolution of the Wick contraction. Note there are redundancies in each product of δ ’s.

Consider a fixed index i : to make things easy, we start by the simple case given by $\mu^{-1}\tilde{\tau}_j\mu\tilde{\sigma}(i) = i$. If $\mu^{-1}\tilde{\tau}_j\mu\tilde{\sigma}^{-1}(i) = i$, then (i) is a 1-cycle of $\mu^{-1}\tilde{\tau}_j\mu\tilde{\sigma}$

and we also have $\tilde{\sigma}(i) = \mu^{-1}\tilde{\tau}\mu(i)$. Thus, we have, among the contraction δ 's, 2 distinct δ 's which become trivial $\delta_{a_i}^{a_i}$ and $\delta_{a_{\tilde{\sigma}(i)}}^{a_{\tilde{\sigma}(i)}}$. The sums over a_i and $a_{\tilde{\sigma}(i)}$ boil down to a single sum precisely because of the vertex $\delta_{a_{\tilde{\sigma}(i)}}^{a_i}$. Hence that cycle is counted once.

Let us inspect the general case. For an arbitrary i , call $q_i \geq 1$ the smallest integer such that $(\mu^{-1}\tilde{\tau}\mu\tilde{\sigma})^{q_i}(i) = i$, and which defines a q_i -cycle of $\mu^{-1}\tilde{\tau}\mu\tilde{\sigma}$. (The case $q_i = 1$ has been dealt above.) In the product (73), we collect all contraction δ 's involved in the cycle starting at some fixed i

$$(74) \quad \prod_{l=1}^{q_i} \delta_{a_{(\mu^{-1}\tilde{\tau}\mu\tilde{\sigma})^l(i)}}^{a_{(\mu^{-1}\tilde{\tau}\mu\tilde{\sigma})^{l-1}(i)}}.$$

Since this product is at arbitrary i , we have a companion and distinct product of contraction δ 's that starts at $\tilde{\sigma}(i)$: $\prod_{l=1}^{q_i} \delta_{a_{(\mu^{-1}\tilde{\tau}\mu\tilde{\sigma})^l(\tilde{\sigma}(i))}}^{a_{(\mu^{-1}\tilde{\tau}\mu\tilde{\sigma})^{l-1}(\tilde{\sigma}(i))}}$. Hence, we combine both products and multiply by one vertex δ

$$(75) \quad \delta_{a_{\tilde{\sigma}(i)}}^{a_i} \prod_{l=1}^{q_i} \delta_{a_{(\mu^{-1}\tilde{\tau}\mu\tilde{\sigma})^l(i)}}^{a_{(\mu^{-1}\tilde{\tau}\mu\tilde{\sigma})^{l-1}(i)}} \delta_{a_{(\mu^{-1}\tilde{\tau}\mu\tilde{\sigma})^l(\tilde{\sigma}(i))}}^{a_{(\mu^{-1}\tilde{\tau}\mu\tilde{\sigma})^{l-1}(\tilde{\sigma}(i))}}$$

which evaluates to N after performing the sum over the corresponding a_j 's. Again, the q_i -cycle is counted once. It just remains to observe that the cycles, each defined by a subset of indices a_j , define partitions of the entire set of indices a_i (once an index is used in a cycle it cannot appear in another one). Thus, the sum over a_i factorizes along cycles and this complete the proof. \square

Note that there may be alternative ways of defining real tensor observables using pairings and without introducing the gauge redundancy. In any case, we could work in this setting, keeping track of the necessary information.

From Lemma 5.1 applied to each color $i = 1, 2, 3$, we finally come to

$$(76) \quad \langle O_{\sigma_1, \sigma_2, \sigma_3}(T) O_{\tau_1, \tau_2, \tau_3}(T) \rangle = \sum_{\mu} N^{\sum_{i=1}^3 c(\mu^{-1}\tilde{\tau}_i\mu\tilde{\sigma}_i)}.$$

The 1pt-correlator can be recovered from the above discussion. First, the 1pt-correlator cannot be normal ordered. Introduce the Wick contraction μ that belongs to S_{2n}^* the subset defined by the pairings of S_{2n} (a permutation pairing is made only of transpositions). Then, we obtain

$$(77) \quad \langle O_{\sigma_1, \sigma_2, \sigma_3}(T) \rangle = \sum_{\mu \in S_{2n}^*} \sum_{a_{ij}} \left[\prod_{i=1}^{2n} \prod_{j=1}^3 \delta_{a_{\tilde{\sigma}_j(i)}}^{a_{ij}} \right] \left[\prod_{i=1}^{2n} \prod_{j=1}^3 \delta_{a_{\mu(i)}}^{a_{ij}} \right].$$

Next, we adapt Lemma 5.1 to $\sum_{a_i} \left[\prod_{i=1}^{2n} \delta_{a_{\tilde{\sigma}(i)}}^{a_i} \delta_{a_{\tilde{\sigma}^{-1}(i)}}^{a_i} \right] = N^{\mathbf{c}(\tilde{\sigma})}$, and then we obtain

$$(78) \quad \langle O_{\sigma_1, \sigma_2, \sigma_3}(T) \rangle = \sum_{\mu \in S_{2n}^*} N^{\sum_{i=1}^3 \mathbf{c}(\mu \tilde{\sigma}_i)}.$$

Representation theoretic base and orthogonality - We re-express the 2pt-function in order to make explicit some of its properties. Inserting 3 auxiliary permutations $\alpha_i \in S_{2n}$, the above sum (76) reads as

$$(79) \quad \begin{aligned} \langle O_{\sigma_1, \sigma_2, \sigma_3}(T) O_{\tau_1, \tau_2, \tau_3}(T) \rangle &= \sum_{\mu} \sum_{\alpha_i} N^{\sum_{i=1}^3 \mathbf{c}(\alpha_i)} \prod_{i=1}^3 \delta(\mu^{-1} \tilde{\tau}_i \mu \tilde{\sigma}_i \alpha_i) \\ &= N^{6n} \sum_{\mu} \prod_{i=1}^3 \delta(\mu^{-1} \tilde{\tau}_i \mu \tilde{\sigma}_i \Omega_i), \end{aligned}$$

where we introduced the central element $\Omega_i = \sum_{\alpha_i \in S_{2n}} N^{\mathbf{c}(\alpha_i) - 2n} \alpha_i$. The proof of that rests on the equality $\mathbf{c}(\alpha_i^{-1}) = \mathbf{c}(\alpha_i)$ and that holds because each cycle has an inverse, a cycle of the same length. Then, we can re-express (79) as

$$(80) \quad \begin{aligned} &\langle O_{\sigma_1, \sigma_2, \sigma_3}(T) O_{\tau_1, \tau_2, \tau_3}(T) \rangle \\ &= N^{6n} \sum_{\mu} \delta[(\mu^{-1})^{\otimes 3} (\tilde{\tau}_1 \otimes \tilde{\tau}_2 \otimes \tilde{\tau}_3) \mu^{\otimes 3} (\tilde{\sigma}_1 \otimes \tilde{\sigma}_2 \otimes \tilde{\sigma}_3) (\Omega_1 \otimes \Omega_2 \otimes \Omega_3)] \\ &= N^{6n} \sum_{\mu} \delta[(\tilde{\tau}_1 \otimes \tilde{\tau}_2 \otimes \tilde{\tau}_3) \mu^{\otimes 3} (\tilde{\sigma}_1 \otimes \tilde{\sigma}_2 \otimes \tilde{\sigma}_3) (\mu^{-1})^{\otimes 3} (\Omega_1 \otimes \Omega_2 \otimes \Omega_3)], \end{aligned}$$

where in the last equation we use the fact the Ω_i are central. We introduce the representation theoretic element by pairing a base element $Q^{R_1, R_2, R_3, \tau}$ (54) and an observable $O_{\sigma_1, \sigma_2, \sigma_3}$ as

$$(81) \quad \begin{aligned} O^{R_1, R_2, R_3, \tau} &= \sum_{\sigma_i} \delta(Q^{R_1, R_2, R_3, \tau} \sigma_1^{-1} \otimes \sigma_2^{-1} \otimes \sigma_3^{-1}) O_{\sigma_1, \sigma_2, \sigma_3} \\ &= \kappa_{\tilde{R}} \left[\prod_{i=1}^3 \frac{\kappa_{R_i}}{2n!} \right] \sum_{\sigma_i} \sum_{p_i, q_i} C_{q_1, q_2; q_3}^{R_1, R_2; R_3, \tau} \left[\prod_{i=1}^3 B_{p_i}^{R_i; tr} D_{p_i q_i}^{R_i}(\sigma_i) \right] O_{\sigma_1, \sigma_2, \sigma_3} \end{aligned}$$

As a linear combination of observables, we can calculate their correlators:

$$\begin{aligned}
 (82) \quad & \langle O^{R_1, R_2, R_3, \tau} O^{R'_1, R'_2, R'_3, \tau'} \rangle \\
 &= N^{6n} \kappa_{\bar{R}} \kappa_{\bar{R}'} \left[\prod_{i=1}^3 \frac{\kappa_{R_i}}{2n!} \frac{\kappa_{R'_i}}{2n!} \right] \sum_{\mu} \delta \left[\sum_{q_1, q_2; q_3} C^{R_1, R_2; R_3, \tau} C^{R'_1, R'_2; R'_3, \tau'} \right. \\
 & \quad \times \left[\prod_{i=1}^3 B_{p_i}^{R_i; tr} D_{p_i q_i}^{R_i}(\sigma_i) B_{p'_i}^{R'_i; tr} D_{p'_i q'_i}^{R'_i}(\sigma'_i) \right] \\
 & \quad \left. \times (\tilde{\sigma}'_1 \otimes \tilde{\sigma}'_2 \otimes \tilde{\sigma}'_3) \mu^{\otimes 3} (\tilde{\sigma}_1 \otimes \tilde{\sigma}_2 \otimes \tilde{\sigma}_3) (\mu^{-1})^{\otimes 3} (\Omega_1 \otimes \Omega_2 \otimes \Omega_3) \right] \\
 &= N^{6n} \kappa_{\bar{R}} \kappa_{\bar{R}'} \left[\prod_{i=1}^3 \frac{\kappa_{R_i}}{2n!} \frac{\kappa_{R'_i}}{2n!} \right] \sum_{\mu} \delta \left[\sum_{p_l, q_l, p'_l, q'_l} C^{R_1, R_2; R_3, \tau} C^{R'_1, R'_2; R'_3, \tau'} \right. \\
 & \quad \times \left[\otimes_{i=1}^3 B_{p'_i}^{R'_i; tr} \sum_{\sigma'_i} (\sigma'_i)^{-1} \xi D_{p'_i q'_i}^{R'_i}(\sigma'_i) \sigma'_i \right] \mu^{\otimes 3} \\
 & \quad \left. \times \left[\otimes_{i=1}^3 B_{p_i}^{R_i; tr} \sum_{\sigma_i} (\sigma_i)^{-1} \xi D_{p_i q_i}^{R_i}(\sigma_i) \sigma_i \right] (\mu^{-1})^{\otimes 3} (\Omega_1 \otimes \Omega_2 \otimes \Omega_3) \right].
 \end{aligned}$$

Next, we introduce the operator $T_{\xi} : S_{2n} \rightarrow S_{2n}$ that acts on S_{2n} as $T_{\xi}(\sigma) = \sigma^{-1} \xi \sigma = \tilde{\sigma}$ and extends by linearity on $\mathbb{C}(S_{2n})$. The operator T_{ξ} actually maps any permutation to a pairing. Its image in $\mathbb{C}(S_{2n})$ is the vector subspace generated by all pairings (more properties are derived in Appendix A.3). We re-express the above correlator as

$$\begin{aligned}
 (83) \quad & \langle O^{R_1, R_2, R_3, \tau} O^{R'_1, R'_2, R'_3, \tau'} \rangle \\
 &= N^{6n} \kappa_{\bar{R}} \kappa_{\bar{R}'} \sum_{\mu} \delta \left[\sum_{p_l, q_l, p'_l, q'_l} C^{R_1, R_2; R_3, \tau} C^{R'_1, R'_2; R'_3, \tau'} \left[\otimes_{i=1}^3 B_{p'_i}^{R'_i; tr} T_{\xi} Q_{p'_i q'_i}^{R'_i} \right] \mu^{\otimes 3} \right. \\
 & \quad \left. \times \left[\otimes_{i=1}^3 B_{p_i}^{R_i; tr} T_{\xi} Q_{p_i q_i}^{R_i} \right] (\mu^{-1})^{\otimes 3} (\Omega_1 \otimes \Omega_2 \otimes \Omega_3) \right] \\
 &= N^{6n} \sum_{\mu} \delta \left[\left[T_{\xi}^{\otimes 3} \sum_{p'_l, q'_l} C^{R'_1, R'_2; R'_3, \tau'} \otimes_{i=1}^3 B_{p'_i}^{R'_i; tr} Q_{p'_i q'_i}^{R'_i} \right] \mu^{\otimes 3} \right. \\
 & \quad \left. \times \left[T_{\xi}^{\otimes 3} \sum_{p_l, q_l} C^{R_1, R_2; R_3, \tau} \otimes_{i=1}^3 B_{p_i}^{R_i; tr} Q_{p_i q_i}^{R_i} \right] (\mu^{-1})^{\otimes 3} (\Omega_1 \otimes \Omega_2 \otimes \Omega_3) \right]
 \end{aligned}$$

$$\begin{aligned}
 &= N^{6n} \sum_{\mu} \delta \left[(T_{\xi}^{\otimes 3} Q^{R'_1, R'_2, R'_3, \tau'}) \mu^{\otimes 3} (T_{\xi}^{\otimes 3} Q^{R_1, R_2, R_3, \tau}) (\mu^{-1})^{\otimes 3} (\Omega_1 \otimes \Omega_2 \otimes \Omega_3) \right] \\
 &= N^{6n} (2n!) \delta \left[(T_{\xi}^{\otimes 3} Q^{R'_1, R'_2, R'_3, \tau'}) (T_{\xi}^{\otimes 3} Q^{R_1, R_2, R_3, \tau}) (\Omega_1 \otimes \Omega_2 \otimes \Omega_3) \right],
 \end{aligned}$$

where we used the right diagonal invariance of the base $Q^{R'_1, R'_2, R'_3, \tau'}$ to achieve the last stage of the calculation. Hence, this correlator computed with the Gaussian measure of $O(N)$ tensor models in the normal order, regarded as an inner product on the space of observables, corresponds to the group theoretic inner product of the algebra $\mathcal{K}_3(2n)$ calculated on a product of the transformed base $T_{\xi}^{\otimes 3} Q^{R_1, R_2, R_3, \tau}$ with an insertion of the factor $\Omega_1 \otimes \Omega_2 \otimes \Omega_3$. The action $T_{\xi}^{\otimes 3}$ on $Q^{R_1, R_2, R_3, \tau}$ reflects the fact that it is the triple $(\tilde{\sigma}_1, \tilde{\sigma}_2, \tilde{\sigma}_3)$ which plays a major role for computing the cycles associated with Feynman amplitudes in this theory (meanwhile the triple $(\sigma_1, \sigma_2, \sigma_3)$ was associated with the class counting of the double coset space and its resulting algebra). In $U(N)$ models [20], there is a correspondence between Gaussian 2pt-correlators in normal order and the inner product on the algebra of observables but without the presence of the operator $T_{\xi}^{\otimes 3}$. The presence of $T_{\xi}^{\otimes 3}$ determines therefore a feature proper to $O(N)$ tensor models.

We can further evaluate the above inner product as in Appendix A.4 and find:

(84)

$$\begin{aligned}
 \langle O^{R_1, R_2, R_3, \tau} O^{R'_1, R'_2, R'_3, \tau'} \rangle &= \left[\prod_{i=1}^3 \delta_{R'_i R_i} \right] \delta_{\tau' \tau} F(R_1, R_2, R_3, \tau) \\
 F(R_1, R_2, R_3, \tau) &= \sum_{S_i, \tau_i} \left[\prod_{i=1}^3 \text{Dim}_N(S_i) \right] \left[\sum_{b_i, c_i, p_i} D_{b_i c_i}^{S_i}(\xi) C_{b_i, c_i; p_i}^{S_i, S_i; R_i, \tau_i} B_{p_i}^{R_i; tr} \right]^2
 \end{aligned}$$

which expresses the orthogonality of the representation theoretic base $\{O^{R_1, R_2, R_3, \tau}\}$ (corresponding to normal ordered Gaussian correlators) of $\mathcal{K}_3(2n)$. Note also that the pairing between base elements is a representation translation of the Gaussian integration.

Rank d 2pt-correlator - We obtain the 2pt-correlator at rank d in a straightforward manner from the above derivation. We generalize (70) and (71) by extending the product over j up to $d \geq 3$ and considering a tensor $T_{a_{i1} a_{i2} \dots a_{id}}$. The calculations are direct: we get (76) and (78) by changing the sum over i running over the colored cycles up to d . Meanwhile, the

orthogonality of the 2pt-function is a property specific to the rank 3 and cannot be reproduced easily at any rank.

6. On $Sp(2N)$ tensor invariants

We provide a few remarks on the counting of real $Sp(2N)$ tensor invariants. Carrozza and Pozsgay recently addressed symplectic complex tensor models in the context of tensor-like SYK models [50]. The authors focused on the complex group $U(N) \cap Sp(2N, \mathbb{C})$ (its quantum mechanical tensor model admits a large N expansion and shares similar properties of the SYK model) and, at the combinatorial level, on the improvement of the numerical computations of the number of its singlets in rank 3. We could ask, in the same vein as discussed above using symmetric group formulae, how to enumerate real symplectic invariants in the pure tensor model setting, i.e. with no spacetime attached to the tensor. We stress that, unlike in [50], we are interested in real and Bosonic fields and address in the following the symplectic group itself $Sp(2N, \mathbb{R}) = Sp(2N)$ and its - symplectic - invariants in any rank. We show below that they follow an enumeration principle with the same diagrammatics of that of the $O(N)$ invariants but some changes occur at the level of the coset equivalence relation. Interestingly in this $Sp(2N)$ setting, the “virtual” vertices v_j^i , in Figure 1, find an interpretation: their correspond precisely to symplectic matrix J insertions in the $Sp(2N)$ invariants.

Let us recall the usual notation and introduce the real $2N \times 2N$ symplectic matrix J which writes in blocks

$$(85) \quad J = \begin{pmatrix} 0 & I_N \\ -I_N & 0 \end{pmatrix}, \quad J^2 = -I_{2N},$$

where I_N , for all N , is the identity matrix of $M_N(\mathbb{R})$. A matrix $K \in Sp(2N)$ obeys $KJK^T = J$, and $K^TJK = J$.

A rank d real tensor T , with components T_{p_1, \dots, p_d} , $p_j = 1, \dots, 2N$, transforms under the fundamental representation of $\otimes_{a=1}^d Sp(2N_a)$ for fixed N_a , if each group $Sp(2N_a)$ acts on the index p_a such that the transformed tensor satisfies:

$$(86) \quad T_{q_1, \dots, q_d}^K = \sum_{p_1, \dots, p_d} K_{q_1 p_1}^{(1)} \cdots K_{q_d p_d}^{(d)} T_{p_1, \dots, p_d},$$

where $K^{(a)} \in Sp(2N_a)$, $a = 1, \dots, d$.

Observables in $Sp(2N)$ tensor models are the contractions of an even number of tensors T . They are invariant under $\otimes_{a=1}^d Sp(2N_a)$ transformations and we call them $Sp(2N)$ invariants.

In understood notation, we define a new trace on two rank d tensors as

$$(87) \quad \text{Tr}(T J^d T) = \sum_{p_i, q_i} J_{p_1 q_1}^{(1)} J_{p_2 q_2}^{(2)} \cdots J_{p_d q_d}^{(d)} T_{p_1, \dots, p_d} T_{q_1, \dots, q_d}.$$

Thus, the tensor indices that are contracted couple with J . This is the generalization of the symplectic form over matrices which is defined as $\omega_J(M, W) = \text{tr}(M^T J W)$, and that is invariant under symplectomorphisms.

We check that $\text{Tr}(T J^d T)$ is invariant under symplectic transformations:

$$(88) \quad \begin{aligned} \text{Tr}(T^K J^d T^K) &= \sum_{r_i, s_i} \sum_{p_i, q_i} (K_{p_1, r_1} K_{q_1, s_1} J_{p_1 q_1}^{(1)}) \cdots (K_{p_d, r_d} K_{q_d, s_d} J_{p_d q_d}^{(d)}) \\ &\quad \times T_{r_1, \dots, r_d} T_{s_1, \dots, s_d} \\ &= \text{Tr}(T J^d T). \end{aligned}$$

Now, we extend the trace (87) to arbitrary number of tensors. Still the contraction obtained is an $Sp(2N)$ invariant. We can easily observe that the $Sp(2N)$ invariants can be viewed once again in terms of ‘ d -regular colored graphs with a decoration on each edge. The decoration seals the symplectic matrix J on each pair of contracted tensor indices. Therefore, J can be represented by a new vertex on each edge which precisely plays the same role of a black vertex v_j^i in Figure 1.

The counting of $Sp(2N)$ invariants is more subtle than that of $O(N)$ invariants. Indeed, for simplicity, let us consider in rank 3 (generalizing the following argument at any rank d is straightforward), $2n$ tensors and count the possible triples $(\sigma_1, \sigma_2, \sigma_3) \in S_{2n} \times S_{2n} \times S_{2n}$ subjected to the following invariance:

$$(89) \quad (\sigma_1, \sigma_2, \sigma_3) \sim (\gamma_1 \sigma_1 \gamma, \gamma_2 \sigma_2 \gamma, \gamma_3 \sigma_3 \gamma)$$

where, on the right, we have the ordinary diagonal action of $\text{Diag}(S_{2n})$ on the triple. Meanwhile, on the left, the γ_i belong to an identical subgroup $G_i = G'$ but that is not any more $S_n[S_2]$. Switching the half-edges of the vertices v_j^i produces a sign. This hints the fact that we should switch to the group algebra $\mathbb{C}(S_{2n}) \times \mathbb{C}(S_{2n}) \times \mathbb{C}(S_{2n})$ to perform the coset. At this point, note that nothing excludes that the number of $Sp(2N)$ invariants matches the number of orthogonal invariants. Such interesting questions require much more work and is left for future investigations.

Let us make a final small remark. At this moment, we can give a precision about the complete graph, namely K_4 , that is identically vanishing in the complex Bosonic model with $U(N) \cap Sp(2N, \mathbb{C})$ invariance, as shown in [50]. In the present setting, we can show that it remains a nontrivial rank 3 symplectic invariant. We have developed a code proving this fact for $Sp(2N = 4)$. See the last code of Appendix B. Of course here $2N = 4$ is not large and rather fixed, and one may question its physical interest. However, it is encouraging to see that it is not identically zero as its counterpart described above. Such a K_4 invariant plays a central role in the study of the large N and IR spectrum of the so-called ladder operators in the tensor-like SYK models. Hence, working with real Bosonic fields but with real $Sp(2N)$ invariance might become an important axis of research in that direction.

7. Conclusion

This paper paves the way to a new formulation of real tensor models, their observables and correlators in terms of symmetric groups and its representation theory. The formulation is particularly convenient for implementing heavy computations using software resources, thus, leading to a gain of confidence in the computational process. Furthermore, with its multiple facets, the formalism elaborated here may shed a different light on the same results since it bridges theories, combinatorics, TFT and physics through observables and correlators, which from the outset may look rather different.

We have enumerated $O(N)$ or rank d real tensor invariants as d -regular colored graphs using a permutation group formalism. These invariants define the points of a double coset of $S_{2n}^{\times d}$. We use Mathematica and Sage codes to generate the sequences associated with the number of these invariants from their generating functions. The sequences obtained at $d \geq 4$ are new according to the OEIS. Translated in the TFT_2 formulation, the same counting delivers the number of covers of gluing of cylinders with defects. Such covers have been also observed while counting Feynman graphs of scalar field theory [26] and relate to a string theory on cylinders. Thus, there should be an equivalent way of describing tensor observables in purely string theory language. Moreover, this link with covers must be made precise: covers in 2D are related to holomorphic maps and may, in return, give a geometry to the space of orthogonal invariants. This point fully deserves further investigation.

Another piece of information reveals itself with the representation theoretic formulation of the counting: the number of orthogonal invariants is a sum of constrained Kronecker coefficients. The Kronecker coefficient is a

core object in Computational Complexity theory: either finding a combinatorial rule describing it (finding which combinatorial objects it counts), or its vanishing property or otherwise remain under active investigation (see references in [39, 40]). It concentrates a lot of research efforts since one expects that, roughly speaking, an understanding that object could lead to a separation of complexity classes P vs NP. In our present work (and in a similar way in [35]), we show that the number of tensor model observables - represented by colored graphs and thus combinatorial structures - links to a sum of Kronecker coefficients (in [35], it is a sum of square of these coefficients). It remains of course the question: how this would help with one of the famous problems stated above? Perhaps a refined counting of colored graphs (endowed with specific properties) could boil down the sum to a single Kronecker element. Such a study could bring some progress in the field.

The equivalence classes associated with the colored graphs are mapped in the tensor product of the group algebra $\mathbb{C}[S_{2n}]^{\otimes d}$. They form the base vectors of a subspace, namely $\mathcal{K}_d(2n)$, that is in fact a semi-simple algebra. We call it a double coset algebra. Note also that, as element of an the algebra, d -regular colored graphs multiply in a specific way, and yield back a combination of d -regular colored graphs. In rank 3, we have found “natural” representation theoretic base, $\{Q^{R,S,T,\tau}\}$, of $\mathcal{K}_3(2n)$, that means invariant and orthonormal. Unlike the unitary case [35], this base decomposes in blocks the algebra but does not provide its Wedderburn-Artin (WA) decomposition in matrix subalgebras. This brings other questions: in which base the WA decomposition is made explicit? Is there a simple enough combination starting from $Q^{R,S,T,\tau}$ that produces that WA decomposition? A starting point of that analysis might be given by the work by Bremner [51] that constructs the WA base of a finite dimensional unital algebra over rationals. Finally, is there a way to understand why the sum of constrained Kronecker coefficients is actually a sum of squares (each of which is the dimension of a matrix subalgebra entering in the WA decomposition)? Such points deserve future clarifications.

We also addressed normal ordered Gaussian 2pt correlators in this work and show that, they formulate completely as a function of the size N of the tensor indices and permutation cycles. We generate an orthogonal representation base from these 2pt correlators. This result is similar to what is observed in the unitary case, with the following distinction: there is an operator acting on the triple defining the observables. We show that computing Gaussian correlators in representation theory space is actually computing an

inner product. Finally, we briefly sketch the main feature of $Sp(2N)$ invariants: although they obey the same diagrammatics of the $O(N)$ invariants, they satisfy a different rule concerning their equivalence classes. Thus, for the symplectic group and its invariants, the story could be radically different from the orthogonal case and will require need more work.

Acknowledgments

JBG thankfully acknowledges discussions with Christophe Tollu, Sanjaye Ramgoolam and Pablo Diaz. RCA was supported by ISF Grant 1050/16. JBG thanks the Laboratoire de Physique Théorique d'Orsay for its hospitality when part of this work was performed. JBG acknowledges a visiting fellowship of Perimeter Institute for Theoretical Physics. This work is supported by Perimeter Institute for Theoretical Physics. Research at Perimeter Institute is supported by the Government of Canada through Industry Canada and by the Province of Ontario through the Ministry of Research and Innovation.

Appendix A. Symmetric group and its representation theory

This appendix gathers useful identities and notations about the symmetric group S_n and its representation theory. The presentation here is a summary of Appendix A, withdrawn from [35], and the textbook by Hammermesh [52].

A.1. Representation theory of the symmetric group

Let n be a positive integer and S_n , the group of permutation of n elements. The Young diagrams or partitions R of n , denoted $R \vdash n$, label the irreducible representations (irreps) of S_n . Consider V_R a space of dimension $d(R)$ (that will be made explicit below). An irreps $\varrho_R : S_n \rightarrow \text{End}(V_R)$ is given by a matrix D^R with entries $\varrho_R(\sigma)|R, i\rangle = \sum_{l=1}^{d(R)} D_{li}^R(\sigma)|R, l\rangle$ with $\sigma \in S_n$ and with $|R, i\rangle$, $i = 1, \dots, d(R)$, an orthogonal base of states for V_R (this base obeys $\langle R, j|R, i\rangle = \delta_{ij}$).

We write in short $\varrho_R(\sigma) = \sigma$ and then $\langle R, j|\sigma|R, i\rangle = D_{ji}^R(\sigma)$. It is common to assimilate the irreducible representation ϱ_R and the carrier space V_R with their label R .

From the commuting action of the unitary group $U(N)$ and S_n on a tensor product space $V^{\otimes n}$, the Schur-Weyl duality teaches us that we associate

an irreps R of S_n with an irreps of $U(N)$, provided N bounds the length $l(R)$ of the first column of R , in symbol $l(R) \leq N$.

Let us denote $d(R)$ the dimension of R and $\text{Dim}_N(R)$ the dimension of an irreps of $U(N)$, then those are given by

$$(A.1) \quad d(R) = n!/h(R), \quad \text{Dim}_N(R) = f_N(R)/h(R),$$

where $h(R)$ is the product of the hook lengths and $f_N(R)$ is the products of box weights given by $h(R) = \prod_{i,j}(c_j - j + r_i - i + 1)$ and $f_N(R) = \prod_{i,j}(N - i + j)$; the pairs (i, j) label the boxes of the Young diagram with i the row label and j is the column label. The i 'th row length is r_i and c_j is the column length of the j 'th column.

We now restrict to real representations and so $D_{ij}^R(\sigma)$ must be real matrices. The matrix satisfies the following properties:

$$(A.2) \quad \sum_i D_{ai}^R(\sigma)D_{ib}^R(\sigma') = D_{ab}^R(\sigma\sigma'), \quad D_{ab}^R(id) = \delta_{ab}, \quad D_{ij}^R(\sigma^{-1}) = D_{ji}^R(\sigma),$$

$$(A.3) \quad \sum_{\sigma \in S_n} D_{ij}^R(\sigma)D_{kl}^S(\sigma) = \frac{n!}{d(R)} \delta_{RS} \delta_{ik} \delta_{jl} \quad (\text{orthogonality}).$$

The character of a given irreps R is simply the trace of $D^R(\sigma)$, $\chi^R(\sigma) = \text{Tr}(D^R(\sigma)) = \sum_i D_{ii}^R(\sigma)$. The Kronecker delta $\delta(\sigma)$ of the symmetric group (defined to be equal 1 when $\sigma = id$ and 0 otherwise) decomposes as $\delta(\sigma) = \sum_{R \vdash n} \frac{d(R)}{n!} \chi^R(\sigma)$.

The following identities are easily proved using the orthogonality relations of the representation matrices:

$$(A.4) \quad \sum_{\gamma \in S_n} \delta(\gamma\sigma\gamma^{-1}\tau^{-1}) = \sum_{R \vdash n} \chi^R(\sigma)\chi^R(\tau),$$

$$\sum_{\sigma \in S_n} \chi^R(\sigma)\chi^S(\sigma) = n! \delta_{RS} \quad (\text{orthogonality})$$

$$(A.5) \quad \sum_{\gamma \in S_n} \chi^R(A\gamma B\gamma^{-1}) = \frac{n!}{d(R)} \chi^R(A)\chi^R(B) \quad \text{If } B \text{ is a central element} \quad \underline{\underline{=}} \quad n! \chi^R(AB).$$

Also a useful identity expresses as

$$(A.6) \quad \frac{1}{n!} \sum_{\sigma} \chi^R(\sigma)N^{\mathbf{c}(\sigma)} = \text{Dim}_N(R), \quad \sum_{\sigma \in S_n} D_{ij}^R(\sigma)N^{\mathbf{c}(\sigma)} = \delta_{ij} f_N(R),$$

where $\mathbf{c}(\sigma)$ is the number of cycles of σ .

Defining the central element $\Omega \in \mathbb{C}(S_n)$, as $\Omega = \sum_{\sigma \in S_n} N^{n-c(\sigma)} \sigma$, the first relation in (A.6) can be also written as

$$(A.7) \quad \frac{N^n}{n!} \chi^R(\Omega) = \text{Dim}_N(R).$$

A.2. Clebsch-Gordan coefficients

Consider two carrier spaces V_{R_1} and V_{R_2} of two irreps of S_n labeled by two Young diagrams R_1 , and R_2 , respectively. The tensor product representation $V_{R_1} \otimes V_{R_2}$ can be decomposed into a direct sum of irreps V_{R_3} with multiplicities

$$(A.8) \quad V_{R_1} \otimes V_{R_2} = \bigoplus_{R_3 \vdash n} V_{R_3} \otimes V_{R_3}^m.$$

The tensor product space is spanned by a tensor product of the base $|R_1, i_1\rangle \otimes |R_2, i_2\rangle =: |R_1, i_1; R_2, i_2\rangle$. On the right hand side, the direct sum corresponds to a base set $|R_3, i_3, \tau_{R_3}\rangle$. The label i_3 runs over states of R_3 , and τ_{R_3} , the so-called multiplicity, runs over an orthogonal base in the multiplicity space $V_{R_3}^m$.

The Clebsch-Gordan coefficients are the branching coefficients between these bases:

$$(A.9) \quad \begin{aligned} C_{i_1, i_2; i_3}^{R_1, R_2; R_3, \tau_{R_3}} &:= \langle R_1, i_1; R_2, i_2 | R_3, \tau_{R_3}, i_3 \rangle \\ &= \langle R_3, \tau_{R_3}, i_3 | R_1, i_1; R_2, i_2 \rangle \end{aligned}$$

Note that they are real.

The following relations are detailed in Appendix A.2 in [35]:

$$(A.10) \quad \sum_{j_1, j_2} D_{i_1 j_1}^{R_1}(\gamma) D_{i_2 j_2}^{R_2}(\gamma) C_{j_1, j_2; j_3}^{R_1, R_2; R_3, \tau} = \sum_{i_3} C_{i_1, i_2; i_3}^{R_1, R_2; R_3, \tau} D_{i_3 j_3}^R(\gamma);$$

$$(A.11) \quad \sum_{i_1, i_2} C_{i_1, i_2; i_3}^{R_1, R_2; R_3, \tau} C_{i_1, i_2; j_3}^{R_1, R_2; R'_3, \tau'} = \delta_{R_3 R'_3} \delta_{\tau \tau'} \delta_{i_3 j_3};$$

$$(A.12) \quad \sum_{R_3, i_3, \tau} C_{i_1, i_2; i_3}^{R_1, R_2; R_3, \tau} C_{j_1, j_2; i_3}^{R_1, R_2; R_3, \tau} = \delta_{i_1 j_1} \delta_{i_2 j_2};$$

$$(A.13) \quad \sum_{R_3, \tau; i_3, j_3} C_{i_1, i_2; i_3}^{R_1, R_2; R_3, \tau} D_{i_3 j_3}^{R_3}(\gamma) C_{j_1, j_2; j_3}^{R_1, R_2; R_3, \tau} = D_{i_1 j_1}^{R_1}(\gamma) D_{i_2 j_2}^{R_2}(\gamma);$$

$$(A.14) \quad \sum_{j_1, j_2, j_3} D_{i_1 j_1}^{R_1}(\gamma) D_{i_2 j_2}^{R_2}(\gamma) D_{i_3 j_3}^{R_3}(\gamma) C_{j_1, j_2; j_3}^{R_1, R_2; R_3, \tau} = C_{i_1, i_2; i_3}^{R_1, R_2; R_3, \tau};$$

$$(A.15) \quad \sum_{i_1, j_1} C_{i_1, i_2; i_3}^{R_1, R_2; R_3, \tau_1} C_{j_1, j_2; j_3}^{R_1, R_2; R_3, \tau_2} \\ \times D_{i_1 j_1}^{R_1}(\gamma_1 \sigma_1 \gamma_2) D_{i_2 j_2}^{R_2}(\gamma_1 \sigma_2 \gamma_2) D_{i_3 j_3}^{R_3}(\gamma_1 \sigma_3 \gamma_2) \\ = \sum_{i_1, j_1} C_{i_1, i_2; i_3}^{R_1, R_2; R_3, \tau_1} C_{j_1, j_2; j_3}^{R_1, R_2; R_3, \tau_2} D_{i_1 j_1}^{R_1}(\sigma_1) D_{i_2 j_2}^{R_2}(\sigma_2) D_{i_3 j_3}^{R_3}(\sigma_3);$$

$$(A.16) \quad \sum_{\sigma \in S_n} D_{i_1 j_1}^{R_1}(\sigma) D_{i_2 j_2}^{R_2}(\sigma) D_{i_3 j_3}^{R_3}(\sigma) = \frac{n!}{d(R_3)} \sum_{\tau} C_{i_1, i_2; i_3}^{R_1, R_2; R_3, \tau} C_{j_1, j_2; j_3}^{R_1, R_2; R_3, \tau}.$$

Furthermore, we can generalize the second relation (A.6) as follows: given two permutations A and B , we have

$$(A.17) \quad \sum_{\sigma \in S_n} D_{ij}^R(\sigma) N^{\mathbf{c}(\sigma^{-1}A\sigma B)} = \sum_{\gamma, \sigma \in S_n} D_{ij}^R(\sigma) \delta(\gamma^{-1}\sigma^{-1}A\sigma B) N^{\mathbf{c}(\gamma)} \\ = \sum_{S, a} \frac{d(S)}{n!} \sum_{\gamma, \sigma} D_{ij}^R(\sigma) D_{aa}^S(\gamma^{-1}\sigma^{-1}A\sigma B) N^{\mathbf{c}(\gamma)} \\ = \sum_{S, a} \frac{d(S)}{n!} \sum_{m, n, o, p} \left[\sum_{\gamma} D_{ma}^S(\gamma) N^{\mathbf{c}(\gamma)} \right] \\ \times \left[\sum_{\sigma} D_{nm}^S(\sigma) D_{op}^S(\sigma) D_{ij}^R(\sigma) \right] D_{no}^S(A) D_{pa}^S(B),$$

with the property $\mathbf{c}(\gamma) = \mathbf{c}(\gamma^{-1})$. We now use (A.6) and (A.16) to write

$$(A.18) \quad \sum_{\sigma \in S_n} D_{ij}^R(\sigma) N^{\mathbf{c}(\sigma^{-1}A\sigma B)} \\ = \sum_{S, a} \frac{d(S)}{n!} \sum_{m, n, o, p} \delta_{ma} f_N(S) \\ \times \left(\frac{n!}{d(R)} \sum_{\tau} C_{n, o; i}^{S, S; R, \tau} C_{m, p; j}^{S, S; R, \tau} \right) D_{no}^S(A) D_{pa}^S(B) \\ = \sum_{S, \tau} \frac{d(S)}{d(R)} f_N(S) \left(\sum_{n, o} C_{n, o; i}^{S, S; R, \tau} D_{no}^S(A) \right) \\ \times \left(\sum_{a, p} C_{a, p; j}^{S, S; R, \tau} D_{pa}^S(B) \right).$$

A.3. Base of the group algebra $\mathbb{C}(S_n)$

The matrix base of the group algebra $\mathbb{C}(S_n)$ is defined by the elements

$$(A.19) \quad Q_{ij}^R = \frac{\kappa_R}{n!} \sum_{\sigma \in S_n} D_{ij}^R(\sigma) \sigma,$$

where the constant $\kappa_R^2 = n!d(R)$ is a fixed by a normalization. The base set $\{Q_{ij}^R\}$ is of cardinality $\sum_{R \vdash n} (d(R))^2 = n!$. The elements Q_{ij}^R form a representation theoretic Fourier base for $\mathbb{C}(S_n)$.

The left and right multiplication by group elements on Q_{ij}^R expand as

$$(A.20) \quad \tau Q_{ij}^R = \sum_l D_{li}^R(\tau) Q_{lj}^R, \quad Q_{ij}^R \tau = \sum_l Q_{il}^R D_{jl}^R(\tau).$$

Using the definition of the base and (A.20), one gets

$$\begin{aligned} Q_{ij}^R Q_{kl}^{R'} &= \frac{\kappa_R \kappa_{R'}}{(n!)^2} \sum_{\sigma \in S_n} \sum_{\tau \in S_n} D_{ij}^R(\sigma) \sigma D_{kl}^{R'}(\tau) \tau = \frac{\kappa_R}{n!} \sum_{\sigma \in S_n} D_{ij}^R(\sigma) \sigma Q_{kl}^{R'} \\ &= \frac{\kappa_R}{n!} \sum_{\sigma \in S_n} D_{ij}^R(\sigma) \sum_m D_{mk}^{R'}(\sigma) Q_{ml}^{R'} = \frac{\kappa_R}{n!} \sum_m \frac{n!}{d(R)} \delta_{RR'} \delta_{im} \delta_{jk} Q_{ml}^{R'} \\ (A.21) \quad &= \frac{\kappa_R}{d(R)} \delta_{RR'} \delta_{jk} Q_{il}^{R'}. \end{aligned}$$

We consider the Kronecker δ on S_n , and extend it (by linearity) as a pairing denoted again δ on $\mathbb{C}(S_n)$, and then once again extend the result to $\mathbb{C}(S_n)^{\otimes d}$, $d > 1$, such that

$$(A.22) \quad \delta(\sigma_1 \otimes \dots \otimes \sigma_d; \sigma'_1 \otimes \dots \otimes \sigma'_d) = \delta(\sigma_1 \sigma_1'^{-1}) \dots \delta(\sigma_d^{-1} \sigma_d'^{-1}).$$

Calculating the inner product $\delta(Q_{ij}^R; Q_{i'j'}^{R'})$, we obtain

$$(A.23) \quad \delta(Q_{ij}^R; Q_{i'j'}^{R'}) = \frac{\kappa_R^2}{n!d(R)} \delta_{RR'} \delta_{ii'} \delta_{jj'} = \delta_{RR'} \delta_{ii'} \delta_{jj'}.$$

Then, for multiple tensor factors, we obtain

$$\begin{aligned} (A.24) \quad &\delta(Q_{i_1 j_1}^{R_1} \otimes \dots \otimes Q_{i_d j_d}^{R_d}; Q_{i'_1 j'_1}^{R'_1} \otimes \dots \otimes Q_{i'_d j'_d}^{R'_d}) \\ &= \delta_{R_1 R'_1} \delta_{i_1 i'_1} \delta_{j_1 j'_1} \dots \delta_{R_d R'_d} \delta_{i_d i'_d} \delta_{j_d j'_d}. \end{aligned}$$

Hence, the base $\{Q_{i_1 j_1}^{R_1} \otimes \dots \otimes Q_{i_d j_d}^{R_d}\}$ is an Fourier theoretic orthonormal base for $\mathbb{C}(S_n)^{\otimes d}$.

In the text, we focus on S_{2n} and we introduce the operator $T_\xi : S_{2n} \rightarrow S_{2n}$ that acts on S_{2n} as $T_\xi(\sigma) = \sigma^{-1}\xi\sigma$. In a natural way, T_ξ extends by linearity on $\mathbb{C}(S_{2n})$. Then, without any possible confusion with the tensor notation T itself, $T_\xi \in \text{End}(\mathbb{C}(S_{2n}))$ is the image of a mapping $T : S_{2n} \rightarrow \text{End}(\mathbb{C}(S_{2n}))$, such that $\xi \mapsto T_\xi$. We then extend T by linearity over $T : \mathbb{C}(S_{2n}) \rightarrow \text{End}(\mathbb{C}(S_{2n}))$, such that $\lambda\xi + \rho \mapsto T_{\lambda\xi + \rho} = \lambda T_\xi + T_\rho$, $\lambda \in \mathbb{C}$.

We are interested in the properties of the transformed base $T_\xi Q_{ij}^R$ which is nothing but the Fourier transformed of the pairing $\sigma^{-1}\xi\sigma$. First, let us see how they multiply:

$$(A.25) \quad (T_\xi Q_{ij}^R) (T_\xi Q_{i'j'}^{R'}) = \frac{\kappa_R \kappa_{R'}}{(2n!)^2} \sum_{\sigma, \rho \in S_{2n}} D_{ij}^R(\sigma) D_{i'j'}^{R'}(\rho) \sigma^{-1} \xi \sigma \rho^{-1} \xi \rho.$$

Note that the group order is now $2n!$. Introduce a change of variable $\sigma \rightarrow \sigma\rho^{-1}$, and

$$(A.26) \quad \begin{aligned} (T_\xi Q_{ij}^R) (T_\xi Q_{i'j'}^{R'}) &= \frac{\kappa_R \kappa_{R'}}{(2n!)^2} \sum_{\sigma, \rho \in S_{2n}} \sum_k D_{ik}^R(\sigma) D_{kj}^R(\rho) D_{i'j'}^{R'}(\rho) \rho^{-1} \sigma^{-1} \xi \sigma \xi \rho \\ &= \frac{\kappa_{R'}}{(2n!)} \sum_{\rho \in S_{2n}} D_{i'j'}^{R'}(\rho) \sum_k D_{kj}^R(\rho) T_{(T_\xi Q_{ik}^R)} \xi(\rho) \\ &= \frac{\kappa_{R'}}{(2n!)} \sum_{\rho \in S_{2n}} D_{i'j'}^{R'}(\rho) T_{\sum_k D_{kj}^R(\rho) (T_\xi Q_{ik}^R)} \xi(\rho). \end{aligned}$$

Thus, the product of the transformed base elements does not re-express easily in terms of the transformed base elements. The left and right multiplications of fixed permutations on the elements $T_\xi Q_{ij}^R$, counterparts of (A.20), are given by:

$$(A.27) \quad \begin{aligned} \tau(T_\xi Q_{ij}^R) &= \sum_a (T_\xi Q_{ia}^R) D_{aj}^R(\tau) \tau, \\ (T_\xi Q_{ij}^R) \tau &= \sum_a (T_\xi Q_{ia}^R) D_{ja}^R(\tau) \tau. \end{aligned}$$

The inner product of these elements expresses as:

$$(A.28) \quad \delta(T_\xi Q_{ij}^R, T_\xi Q_{i'j'}^{R'}) = \frac{\kappa_R \kappa_{R'}}{(2n!)^2} \sum_{\sigma, \rho \in S_{2n}} D_{ij}^R(\sigma) D_{i'j'}^{R'}(\rho) \delta(T_\xi(\sigma), T_\xi(\rho)).$$

This is simply the Fourier transform of the delta $\delta(\sigma^{-1}\xi\sigma\rho^{-1}\xi\rho)$ which tells us that the sole terms remaining in this sum are those which define the same pairing. A closer look shows that $\delta(\sigma^{-1}\xi\sigma\rho^{-1}\xi\rho) = \delta(\xi\sigma\rho^{-1}\xi\rho\sigma^{-1})$. Then,

this means that the elements that contribute to the sum are those $\sigma\rho^{-1}$ that belong to the stabilizer of ξ , that is $\sigma\rho^{-1} \in S_n[S_2]$. Hence, we change variable as $\sigma \rightarrow \bar{\sigma} = \sigma\rho^{-1}$, rename again $\bar{\sigma}$ as σ and then rewrite, using the orthogonality of the representation matrices:

$$\begin{aligned}
 \text{(A.29)} \quad & \delta(T_\xi Q_{ij}^R, T_\xi Q_{i'j'}^{R'}) = \frac{\kappa_R \kappa_{R'}}{(2n!)^2} \sum_{\rho \in S_{2n}} \sum_{\sigma \in S_n[S_2]} D_{ij}^R(\sigma\rho) D_{i'j'}^{R'}(\rho) \\
 &= \frac{\kappa_R \kappa_{R'}}{(2n!)^2} \sum_a \sum_{\sigma \in S_n[S_2]} D_{ia}^R(\sigma) \sum_{\rho \in S_{2n}} D_{aj}^R(\rho) D_{i'j'}^{R'}(\rho) \\
 &= \delta_{RR'} \delta_{jj'} \frac{\kappa_R^2}{(2n!)^2} \frac{2n!}{d(R)} \sum_a \sum_{\sigma \in S_n[S_2]} D_{ia}^R(\sigma) \delta_{ai'} \\
 &= \delta_{RR'} \delta_{jj'} \sum_{\sigma \in S_n[S_2]} D_{ii'}^R(\sigma).
 \end{aligned}$$

In the text, we compute a formula for that sum in terms of branching coefficients, see (52). It turns out that the sum is nonvanishing only if the partition R is even, meaning that the length of each of its rows is even. Hence, from the above relation, (A.29), the set of the transformed base elements does not form an orthogonal system.

It is instructive to perform the same evaluation in an alternative way to discover new identities satisfied by the Clebsch-Gordan coefficients. Consider the expansion of the above inner product as follows:

$$\begin{aligned}
 \delta(T_\xi Q_{ij}^R, T_\xi Q_{i'j'}^{R'}) &= \frac{\kappa_R \kappa_{R'}}{(2n!)^2} \sum_S \frac{d(S)}{2n!} \sum_{\sigma, \rho \in S_n} D_{ij}^R(\sigma) D_{i'j'}^{R'}(\rho) \chi^S(\sigma^{-1} \xi \sigma \rho^{-1} \xi \rho) \\
 &= \frac{\kappa_R \kappa_{R'}}{(2n!)^2} \sum_S \frac{d(S)}{2n!} \sum_{a,b,c,d,e,f} D_{bc}^S(\xi) D_{ef}^S(\xi) \\
 &\quad \times \sum_{\sigma, \rho} D_{ba}^S(\sigma) D_{cd}^S(\sigma) D_{ij}^R(\sigma) D_{fa}^S(\rho) D_{ed}^S(\rho) D_{i'j'}^{R'}(\rho) \\
 &= \frac{\kappa_R \kappa_{R'}}{(2n!)^2} \sum_S \frac{d(S)}{2n!} \sum_{b,c,e,f} D_{bc}^S(\xi) D_{ef}^S(\xi) \frac{(2n!)^2}{d(R)d(R')} \\
 &\quad \times \sum_{\tau, \tau'} C_{b,c;i}^{S,S;R,\tau} C_{f,e;i'}^{S,S;R',\tau'} \sum_{a,d} C_{a,d;j}^{S,S;R,\tau} C_{a,d;j'}^{S,S;R',\tau'} \\
 &= \frac{\kappa_R \kappa_{R'}}{d(R)d(R')} \sum_S \frac{d(S)}{2n!} \sum_{b,c,e,f} D_{bc}^S(\xi) D_{ef}^S(\xi) \\
 &\quad \times \sum_{\tau, \tau'} C_{b,c;i}^{S,S;R,\tau} C_{f,e;i'}^{S,S;R',\tau'} \delta_{RR'} \delta_{\tau\tau'} \delta_{jj'}
 \end{aligned}$$

$$\begin{aligned}
 &= \delta_{RR'} \delta_{jj'} \frac{\kappa_R^2}{d(R)^2} \sum_{S,\tau} \frac{d(S)}{2n!} \sum_{b,c,e,f} D_{bc}^S(\xi) D_{ef}^S(\xi) C_{b,c;i}^{S,S;R,\tau} C_{f,e;i'}^{S,S;R,\tau} \\
 \text{(A.30)} \quad &= \delta_{RR'} \delta_{jj'} \frac{1}{d(R)} \sum_{S,\tau} d(S) F(S, R, \tau; i) F(S, R, \tau; i'),
 \end{aligned}$$

where, at some intermediate steps, we used successively (A.16) and (A.11), and where $F(S, R, \tau; i) = \sum_{b,c} D_{bc}^S(\xi) C_{b,c;i}^{S,S;R,\tau}$. Using $\sum_{\sigma \in S_n[S_2]} D_{ij}^R(\sigma) = (2^n n!) B_i^{R;tr} B_j^{R;tr}$ (see (52)), we arrive to a new identity:

$$\begin{aligned}
 \text{(A.31)} \quad &\sum_{S,\tau} d(S) \left(\sum_{b,c} D_{bc}^S(\xi) C_{b,c;i}^{S,S;R,\tau} \right) \left(\sum_{e,f} D_{ef}^S(\xi) C_{e,f;j}^{S,S;R,\tau} \right) \\
 &= \frac{(2^n n!)}{d(R)} B_i^{R;tr} B_j^{R;tr}.
 \end{aligned}$$

Note the similarity of the left-hand-side member with (A.18) (adjusted for the symmetric group S_{2n}).

There exist graphical ways of representing identities in representation theory in general. For the permutation group, Appendix A2 of [35] lists such graphical representations for most of the identities given above. For instance, we use the graphical representation of the representation matrix $D_{ij}^R(\sigma)$ as $i \begin{array}{|c|} \hline \sigma \\ \hline \end{array} j$, the Clebsch-Gordan coefficient $C_{i_1,i_2,i_3}^{R_2,R_2;R_3,\tau}$ represents as

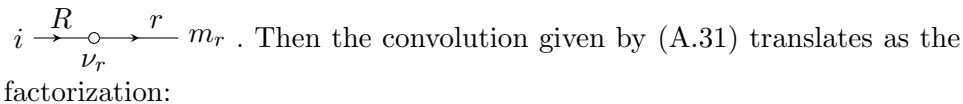
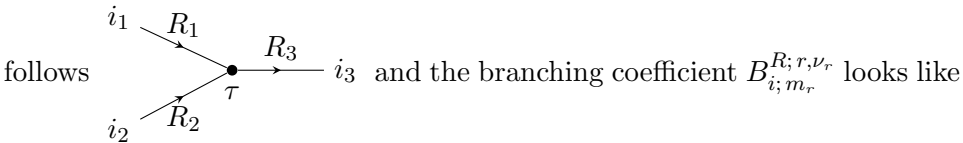

$$\text{(A.32)} \quad \sum_{S,\tau} d(S) i \begin{array}{c} \xrightarrow{R} \bullet \\ \begin{array}{c} \curvearrowright^S \\ \curvearrowleft_S \end{array} \\ \xrightarrow{\tau} \end{array} \begin{array}{|c|} \hline \xi \\ \hline \end{array} \begin{array}{c} \begin{array}{c} \curvearrowright^S \\ \curvearrowleft_S \end{array} \\ \xrightarrow{\tau} \bullet \\ \xrightarrow{R} \end{array} j = \frac{(2^n n!)}{d(R)} \begin{array}{c} i \xrightarrow{R} \circ \xrightarrow{tr} 0 \\ \quad \quad \quad 1 \\ j \xrightarrow{R} \circ \xrightarrow{tr} 0 \\ \quad \quad \quad 1 \end{array},$$

hence, a new identity satisfied by the Clebsch-Gordan of the symmetric group.

A.4. 2pt-correlator evaluation

We prove in this part (84). To proceed, we will make use of (A.6), (A.11) and (A.16), or alternatively (A.18), of Appendix A.2. Introducing $k_{\vec{R}} = \kappa_{\vec{R}} \frac{\kappa_{R_1} \kappa_{R_2} \kappa_{R_3}}{(2n!)^3}$, then from (83), we focus on the δ function:

$$\begin{aligned}
 (A.33) \quad & \delta \left[(T_{\xi}^{\otimes 3} Q^{R_1, R_2, R_3, \tau'}) (T_{\xi}^{\otimes 3} Q^{R_1, R_2, R_3, \tau}) (\Omega_1 \otimes \Omega_2 \otimes \Omega_3) \right] \\
 &= k_{\vec{R}} k'_{\vec{R}} \sum_{p_i, q_i, p'_i, q'_i} C_{q_1, q_2, q_3}^{R_1, R_2, R_3, \tau} C_{q'_1, q'_2, q'_3}^{R'_1, R'_2, R'_3, \tau'} \left[\prod_{i=1}^3 B_{p'_i}^{R'_i; tr} B_{p_i}^{R_i; tr} \right] \\
 & \quad \times \sum_{\sigma'_i, \sigma_i} \sum_{\alpha_i} \left[\prod_{i=1}^3 N^{\mathbf{c}(\alpha_i) - 2n} \right] \\
 & \quad \times \left[\prod_{i=1}^3 D_{p'_i q'_i}^{R'_i}(\sigma'_i) D_{p_i q_i}^{R_i}(\sigma_i) \delta((\sigma'_i)^{-1} \xi \sigma'_i (\sigma_i)^{-1} \xi \sigma_i \alpha_i) \right] \\
 &= k_{\vec{R}} k'_{\vec{R}} \sum_{p_i, q_i, p'_i, q'_i} C_{q_1, q_2, q_3}^{R_1, R_2, R_3, \tau} C_{q'_1, q'_2, q'_3}^{R'_1, R'_2, R'_3, \tau'} \\
 & \quad \times \left[\prod_{i=1}^3 B_{p'_i}^{R'_i; tr} B_{p_i}^{R_i; tr} \right] \sum_{\sigma'_i, \sigma_i} \left[\prod_{i=1}^3 D_{p'_i q'_i}^{R'_i}(\sigma'_i) D_{p_i q_i}^{R_i}(\sigma_i) \right] \\
 & \quad \times \sum_{S_i, a_i, g_i} \sum_{\alpha_i} \left[\prod_{i=1}^3 N^{\mathbf{c}(\alpha_i) - 2n} D_{g_i a_i}^{S_i}(\alpha_i) \right] \\
 & \quad \times \sum_{b_i, c_i, d_i, e_i, f_i} \prod_{i=1}^3 \frac{d(S_i)}{2n!} D_{a_i b_i}^{S_i}((\sigma'_i)^{-1}) D_{b_i c_i}^{S_i}(\xi) D_{c_i d_i}^{S_i}(\sigma'_i) \\
 & \quad \quad \times D_{d_i e_i}^{S_i}((\sigma_i)^{-1}) D_{e_i f_i}^{S_i}(\xi) D_{f_i g_i}^{S_i}(\sigma_i) \\
 &= k_{\vec{R}} k'_{\vec{R}} \frac{N^{-6n}}{(2n!)^3} \sum_{p_i, q_i, p'_i, q'_i} C_{q_1, q_2, q_3}^{R_1, R_2, R_3, \tau} C_{q'_1, q'_2, q'_3}^{R'_1, R'_2, R'_3, \tau'} \\
 & \quad \times \left[\prod_{i=1}^3 B_{p'_i}^{R'_i; tr} B_{p_i}^{R_i; tr} \right] \sum_{S_i, a_i, g_i} \left[\prod_{i=1}^3 \delta_{g_i a_i} f_N(S_i) d(S_i) \right] \\
 & \quad \times \sum_{b_i, c_i, d_i, e_i, f_i} \sum_{\sigma'_i, \sigma_i} \left[\prod_{i=1}^3 D_{b_i a_i}^{S_i}(\sigma'_i) D_{c_i d_i}^{S_i}(\sigma'_i) D_{p'_i q'_i}^{R'_i}(\sigma'_i) \right. \\
 & \quad \left. \times D_{f_i g_i}^{S_i}(\sigma_i) D_{e_i d_i}^{S_i}(\sigma_i) D_{p_i q_i}^{R_i}(\sigma_i) \right] \left[\prod_{i=1}^3 D_{b_i c_i}^S(\xi) D_{e_i f_i}^S(\xi) \right].
 \end{aligned}$$

It is the moment to use (A.16) to integrate the representation matrices and get:

$$\begin{aligned}
 (A.34) \quad & k_{\bar{R}} k'_{\bar{R}} \frac{N^{-6n}}{(2n!)^3} \sum_{p_l, q_l, p'_l, q'_l} C_{q_1, q_2; q_3}^{R_1, R_2; R_3, \tau} C_{q'_1, q'_2; q'_3}^{R'_1, R'_2; R'_3, \tau'} \\
 & \times \left[\prod_{i=1}^3 B_{p'_i}^{R'_i; tr} B_{p_i}^{R_i; tr} \right] \sum_{S_i} \left[\prod_{i=1}^3 (2n!) \text{Dim}_N(S_i) \right] \\
 & \times \sum_{a_i, b_i, c_i, d_i, e_i, f_i} \prod_{i=1}^3 \left[\frac{2n!}{d(R_i) d(R'_i)} \sum_{\tau'_i, \tau_i} C_{b_i, c_i; p'_i}^{S_i, S_i; R'_i, \tau'_i} C_{a_i, d_i; q'_i}^{S_i, S_i; R_i, \tau_i} \right. \\
 & \times \left. C_{f_i, e_i; p_i}^{S_i, S_i; R_i, \tau_i} C_{a_i, d_i; q_i}^{S_i, S_i; R_i, \tau_i} \right] \left[\prod_{i=1}^3 D_{b_i c_i}^{S_i}(\xi) D_{e_i f_i}^{S_i}(\xi) \right] \\
 & = k_{\bar{R}}^2 N^{-6n} \prod_{i=1}^3 \left[\frac{2n!}{d(R_i) d(R'_i)} \right] \sum_{p_l, q_l, p'_l, q'_l} C_{q_1, q_2; q_3}^{R_1, R_2; R_3, \tau} C_{q'_1, q'_2; q'_3}^{R'_1, R'_2; R'_3, \tau'} \\
 & \times \left[\prod_{i=1}^3 B_{p'_i}^{R'_i; tr} B_{p_i}^{R_i; tr} \right] \sum_{S_i} \left[\prod_{i=1}^3 \text{Dim}_N(S_i) \right] \\
 & \times \sum_{b_i, c_i, e_i, f_i} \prod_{i=1}^3 \left[\sum_{\tau'_i, \tau_i} C_{b_i, c_i; p'_i}^{S_i, S_i; R'_i, \tau'_i} C_{f_i, e_i; p_i}^{S_i, S_i; R_i, \tau_i} \delta_{R'_i R_i} \delta_{\tau'_i \tau_i} \delta_{q'_i q_i} \right] \\
 & \times \left[\prod_{i=1}^3 D_{b_i c_i}^{S_i}(\xi) D_{e_i f_i}^{S_i}(\xi) \right] \\
 & = \frac{(2n!)^3 k_{\bar{R}}^2 N^{-6n}}{\prod_{i=1}^3 d(R_i)^2} \left[\prod_{i=1}^3 \delta_{R'_i R_i} \right] \sum_{p_l, q_l, p'_l} C_{q_1, q_2; q_3}^{R_1, R_2; R_3, \tau} C_{q_1, q_2; q_3}^{R_1, R_2; R_3, \tau'} \\
 & \times \left[\prod_{i=1}^3 B_{p'_i}^{R'_i; tr} B_{p_i}^{R_i; tr} \right] \sum_{S_i} \left[\prod_{i=1}^3 \text{Dim}_N(S_i) \right] \\
 & \times \sum_{b_i, c_i, e_i, f_i} \prod_{i=1}^3 \left[\sum_{\tau_i} C_{b_i, c_i; p'_i}^{S_i, S_i; R_i, \tau_i} C_{f_i, e_i; p_i}^{S_i, S_i; R_i, \tau_i} \right] \left[\prod_{i=1}^3 D_{b_i c_i}^{S_i}(\xi) D_{e_i f_i}^{S_i}(\xi) \right] \\
 & = \kappa_{\bar{R}}^2 N^{-6n} \left[\prod_{i=1}^3 \delta_{R'_i R_i} \right] \delta_{\tau' \tau} \sum_{q_3} \delta_{q_3 q_3} \sum_{p_l, p'_l} \left[\prod_{i=1}^3 B_{p'_i}^{R'_i; tr} B_{p_i}^{R_i; tr} \right] \\
 & \times \sum_{S_i} \left[\prod_{i=1}^3 \text{Dim}_N(S_i) \right] \sum_{b_i, c_i, e_i, f_i} \prod_{i=1}^3 \left[\sum_{\tau_i} C_{b_i, c_i; p'_i}^{S_i, S_i; R_i, \tau_i} C_{f_i, e_i; p_i}^{S_i, S_i; R_i, \tau_i} \right] \\
 & \times \left[\prod_{i=1}^3 D_{b_i c_i}^{S_i}(\xi) D_{e_i f_i}^{S_i}(\xi) \right]
 \end{aligned}$$

$$\begin{aligned}
 &= \kappa_{\bar{R}}^2 d(R_3) N^{-6n} \left[\prod_{i=1}^3 \delta_{R'_i R_i} \right] \delta_{\tau' \tau} \sum_{S_i, \tau_i} \left[\prod_{i=1}^3 \text{Dim}_N(S_i) \right] \\
 &\quad \times \prod_{i=1}^3 \left[\sum_{b_i, c_i, p'_i} D_{b_i c_i}^{S_i}(\xi) C_{b_i, c_i; p'_i}^{S_i, S_i; R_i, \tau_i} B_{p'_i}^{R_i; tr} \right] \left[\sum_{p_i, e_i, f_i} D_{e_i f_i}^{S_i}(\xi) C_{f_i, e_i; p_i}^{S_i, S_i; R_i, \tau_i} B_{p_i}^{R_i; tr} \right] \\
 &= N^{-6n} \left[\prod_{i=1}^3 \delta_{R'_i R_i} \right] \delta_{\tau' \tau} \sum_{S_i, \tau_i} \left[\prod_{i=1}^3 \text{Dim}_N(S_i) \right] \\
 &\quad \times \left[\sum_{b_i, c_i, p_i} D_{b_i c_i}^{S_i}(\xi) C_{b_i, c_i; p_i}^{S_i, S_i; R_i, \tau_i} B_{p_i}^{R_i; tr} \right]^2.
 \end{aligned}$$

The evaluation finally yields

(A.35)

$$\begin{aligned}
 \langle O^{R_1, R_2, R_3, \tau} O^{R'_1, R'_2, R'_3, \tau'} \rangle &= \left[\prod_{i=1}^3 \delta_{R'_i R_i} \right] \delta_{\tau' \tau} F(R_1, R_2, R_3, \tau) \\
 F(R_1, R_2, R_3, \tau) &= \sum_{S_i, \tau_i} \left[\prod_{i=1}^3 \text{Dim}_N(S_i) \right] \left[\sum_{b_i, c_i, p_i} D_{b_i c_i}^{S_i}(\xi) C_{b_i, c_i; p_i}^{S_i, S_i; R_i, \tau_i} B_{p_i}^{R_i; tr} \right]^2.
 \end{aligned}$$

This is (84) and implies the orthogonality of the representation theoretic base $\{O^{R_1, R_2, R_3, \tau}\}$.

Appendix B. Codes

We list here some algorithms which count the number of orthogonal invariants as given in the text. We use Mathematica and Sage softwares in the following.

Mathematica code for $Z_d(t)$. We wish to compute the number $Z_d(2n)$ of rank d orthogonal invariants made with $2n$ tensors. In order to obtain that number, we first code the generating function, denoted $Z[\mathbf{X}, \mathbf{t}]$, of the counting of the number of elements of the wreath product $S_n[S_2]$ in a certain conjugacy class of S_{2n} . Doing this, we use the built-in function `Count[list, pattern]` which counts the number of elements in a `list` matching a `pattern`. Then, we extract a coefficient of t^n in $Z[\mathbf{X}, \mathbf{t}]$ that is involved in `Zd[X, n, d]` that encodes $Z_d(2n)$. We finally give the counting for ranks 3 and 4, successively, for $n = 1, \dots, 10$.

```

X = Array[x, 20];
PP[n_] := IntegerPartitions[n]
Sym[q_, n_] := Product[i^(Count[q, i]) Count[q, i]!, {i, 1, n}]
Symd[X_, k_, q_] := Product[(X[[k*1]]/1)^(Count[q, 1])
                             /((Count[q, 1]!), {1, 1, 2}]

Z[X_, t_] := Product[Exp[(t^i/i)*Sum[Symd[X, i, PP[2][[j]]],
                                   {j, 1, Length[PP[2]]}]], {i, 1, 15}]
Zprim[X_, n_] := Coefficient[Series[Z[X, t], {t, 0, n}], t^n]
CC[X_, n_, q_] := Coefficient[Zprim[X, n],
                               Product[X[[i]]^(Count[q, i]), {i, 1, 2*n}]]
Zd[X_, n_, d_] := Sum[(CC[X, n, PP[2*n][[i]]])^d*(Sym[PP[2*n][[i]],
2*n])^(d - 1), {i, 1, Length[PP[2*n]]}]

Table[Zd[X, i, 3], {i, 1, 10}]

(out) {1, 5, 16, 86, 448, 3580, 34981, 448628, 6854130, 121173330}

Table[Zd[X, i, 4], {i, 1, 10}]

(out) {1, 14, 132, 4154, 234004, 24791668, 3844630928, 809199787472,
220685007519070, 75649235368772418}

```

Mathematica code: Counting with Hermite polynomials. This part is dedicated to the implementation of an algorithm realizing Read's enumeration of k -regular graphs on $2n$ vertices with edges of k different colors where one of each color is at every vertex. We want to compare Read's results with the previous sequences.

Read's generating function that encodes the above enumeration denotes $ZR[t, d, n]$, in the following program. Then, $ZR[d, n]$ yields the counting at rank d with $2n$ vertices and that is given by the coefficient of t^n in $ZR[t, d, n]$. We evaluate $Z_3(2n)$ and $Z_4(2n)$ for the ranks 3 and 4, respectively, and confirm that the results of Read match with the previous results.

Next, the number of connected rank d tensor invariants made with $2n$ tensors, written below $ZRc[d, n]$, can be obtained using the plethystic logarithm (Plog) function. The Plog function $\text{Plog}Z_d(t)$, denoted $\text{Plog}[ZR, t, d, n]$, is defined with the `MoebiusMu` implementing the Möbius function.

```

A[p_, v_] := (I Sqrt[p])^v HermiteH[v, 1/(2 I Sqrt[p])]
ZR[t_, d_, n_] = 1;

For[m = 0, m <= 20, m++
  {If [OddQ[m],

```

```

Phi[m, t_, d_, n_] := (Sum[((2 v)!)^(d - 1)/(v!)^(d)*
  (m^(d - 2)/2^d)^v t^(m v), {v, 0, n}]),
Phi[m, t_, d_, n_] := (Sum[(A[m/2, v])^d/(v! m^v) t^(m v/2),
  {v, 0, n}]]
);
ZR[t_, d_, n_] = ZR[t, d, n]*Phi[m, t, d, n]
]

ZR[d_, n_] := Coefficient[Series[ZR[t, d, n], {t, 0, n}], t^n]
Plog[F_, t_, d_, n_] := Sum[MoebiusMu[i]/i
  Log[F[t^i, d, n]], {i, 1, n}]
ZRc[d_, n_] := Coefficient[Series[Plog[ZR, t, d, n], {t, 0, n}], t^n]

Table[ZR[3, i], {i, 1, 10}]

(Out) {1, 5, 16, 86, 448, 3580, 34981, 448628, 6854130, 121173330}

Table[ZR[4, i], {i, 1, 10}]

(Out) {1, 14, 132, 4154, 234004, 24791668, 3844630928, 809199787472,
220685007519070, 75649235368772418}

Table[ZRc[3, i], {i, 1, 10}]

(Out) {1, 4, 11, 60, 318, 2806, 29359, 396196, 6231794, 112137138}

Table[ZRc[4, i], {i, 1, 10}]

(Out) {1, 13, 118, 3931, 228316, 24499085, 3816396556, 805001547991,
219822379032704, 75417509926065404}

```

Sage code: Counting from the sum of Kroneckers in rank $d = 3$. We provide here a Sage code that recovers the same counting through the sum of constrained Kronecker coefficients with even partitions (30).

We need the library `SymmetricFunctions(QQ)` which introduces symmetric functions. The Kronecker coefficient associated with three partitions R, S and T deduces as the usual Hall scalar product of Schur symmetric functions. In the following, $s(S)$ is the Schur function associated with the partition S .

```

s = SymmetricFunctions(QQ).s()
for n in range(1,4) :
  Total=0
  for R in Partitions(2*n) :

```

```

i=0
rep=0
while ( ( i < R.length() ) & ( rep==0 ) ):
    if ( ( R.get_part(i)%2 ) !=0 ):
        rep = 1
    i=i+1
if ( rep ==0 ) :
    for S in Partitions ( 2*n ) :
        j=0
        rep2=0
        while ( ( j < S.length() ) & ( rep2==0 ) ):
            if ( ( S.get_part(j)%2 ) !=0 ):
                rep2 = 1
            j=j+1
        if ( rep2 ==0 ) :
            for T in Partitions ( 2*n ) :
                k=0
                rep3=0
                while ( ( k < T.length() ) & ( rep3==0 ) ):
                    if ( ( T.get_part(k)%2 ) !=0 ):
                        rep3 = 1
                    k=k+1
                if ( rep3 ==0 ) :
                    a = ( s(S).itensor(s(T)) ).scalar( s(R) )
                    Total =Total+a

print "Number of invariants at 2n =", 2*n, "is", Total

```

```

(out) Number of invariants at 2n = 2 is 1
Number of invariants at 2n = 4 is 5
Number of invariants at 2n = 6 is 16
Number of invariants at 2n = 8 is 86

```

Sage code: The symplectic K_4 invariant is not vanishing at $d = 3$.

The present Sage code computes a specific invariant, given by complete graph K_4 with colored edges. The tensor rank is $d = 3$ and the symplectic group $Sp(2N = 4)$. We then extract a coefficient of the resulting polynomial which does not vanish. Thus this $Sp(4)$ invariant exists.

The list T of variables denoted T_ijk represents the rank 3 tensor. We then need bijections to map T[1] \leftrightarrow T_ijk. This is the work of f and f_inv. J4 is the symplectic matrix of size $2N = 4$. To speed up the computation, whenever possible, we perform multiplications outside the cascade of internal loops when the factors multiplied do not involve the variable of that loop.

```
t.coefficient(T_000*T_000)
```

```
(Out) 0
```

```
t.coefficient(T_000)
```

```
(Out) 4*T_032*T_212*T_220 - 4*T_023*T_202*T_221 + 4*T_022*T_203*T_221
+ 4*T_032*T_213*T_221 + 4*T_023*T_201*T_222 - 4*T_021*T_203*T_222
- 4*T_032*T_210*T_222 - 4*T_022*T_201*T_223 + 4*T_021*T_202*T_223
- 4*T_032*T_211*T_223 - 4*T_022*T_212*T_230 + 4*T_012*T_222*T_230
- 4*T_023*T_212*T_231 + 4*T_012*T_223*T_231 + 4*T_022*T_210*T_232
+ 4*T_023*T_211*T_232 - 4*T_021*T_213*T_232 - 4*T_012*T_220*T_232
+ 4*T_021*T_212*T_233 - 4*T_012*T_221*T_233 - 4*T_122*T_220*T_302
- 4*T_123*T_221*T_302 + 4*T_120*T_222*T_302 + 4*T_121*T_223*T_302
- 4*T_122*T_230*T_312 - 4*T_123*T_231*T_312 + 4*T_120*T_232*T_312
+ 4*T_121*T_233*T_312 + 4*T_122*T_202*T_320 + 4*T_132*T_212*T_320
- 4*T_102*T_222*T_320 - 4*T_112*T_232*T_320 + 4*T_122*T_203*T_321
+ 4*T_132*T_213*T_321 - 4*T_102*T_223*T_321 - 4*T_112*T_233*T_321
+ 4*T_123*T_201*T_322 - 4*T_120*T_202*T_322 - 4*T_121*T_203*T_322
- 4*T_132*T_210*T_322 + 4*T_102*T_220*T_322 + 4*T_112*T_230*T_322
- 4*T_122*T_201*T_323 - 4*T_132*T_211*T_323 + 4*T_102*T_221*T_323
+ 4*T_112*T_231*T_323 + 4*T_122*T_210*T_332 + 4*T_123*T_211*T_332
- 4*T_120*T_212*T_332 - 4*T_121*T_213*T_332
```

```
t.coefficient(T_032*T_212*T_220)
```

```
(Out) 4*T_000
```

References

- [1] J. Ambjorn, B. Durhuus, and T. Jonsson, *Three-dimensional simplicial quantum gravity and generalized matrix models*, Mod. Phys. Lett. A **6** (1991) 1133.
- [2] M. Gross, *Tensor models and simplicial quantum gravity in > 2 -D*, Nucl. Phys. Proc. Suppl. **25A** (1992) 144.
- [3] N. Sasakura, *Tensor model for gravity and orientability of manifold*, Mod. Phys. Lett. A **6** (1991) 2613.
- [4] P. Di Francesco, P. H. Ginsparg, and J. Zinn-Justin, *2-D Gravity and random matrices*, Phys. Rept. **254** (1995) 1.
- [5] R. Gurau, *Random Tensors*, Oxford University Press, Oxford, (2016).

- [6] G. 't Hooft, *A planar diagram theory for strong interactions*, Nucl. Phys. B **72** (1974) 461.
- [7] R. Gurau, *The complete $1/N$ expansion of colored tensor models in arbitrary dimension*, Annales Henri Poincare **13** (2012) 399.
- [8] V. Bonzom, R. Gurau, A. Riello, and V. Rivasseau, *Critical behavior of colored tensor models in the large N limit*, Nucl. Phys. B **853** (2011) 174.
- [9] R. Gurau and J. P. Ryan, *Melons are branched polymers*, Annales Henri Poincare **15** (2014), no. 11, 2085.
- [10] R. Gurau, *Universality for random tensors*, Ann. Inst. H. Poincare Probab. Statist. **50** (2014), no. 4, 1474.
- [11] J. Ben Geloun and V. Rivasseau, *A renormalizable 4-dimensional tensor field theory*, Commun. Math. Phys. **318** (2013) 69.
- [12] J. Ben Geloun, *Renormalizable models in rank $d \geq 2$ tensorial group field theory*, Commun. Math. Phys. **332** (2014) 117.
- [13] S. Carrozza, *Tensorial methods and renormalization in group field theories*, Springer Theses, 2014 (Springer, NY, 2014).
- [14] A. Eichhorn and T. Koslowski, *Flowing to the continuum in discrete tensor models for quantum gravity*, Ann. Inst. H. Poincare Comb. Phys. Interact. **5** (2018), no. 2, 173.
- [15] A. Eichhorn, T. Koslowski, J. Lumma, and A. D. Pereira, *Towards background independent quantum gravity with tensor models*, arXiv:1811.00814 [gr-qc].
- [16] A. Eichhorn, T. Koslowski, and A. D. Pereira, *Status of background-independent coarse-graining in tensor models for quantum gravity*, Universe **5** (2019), no. 2, 53.
- [17] A. Kitaev, *A simple model of quantum holography*, Talks at KITP, April 7, 2015 and May 27, 2015, <http://online.kitp.ucsb.edu/online/entangled15/kitaev/>.
- [18] J. Maldacena and D. Stanford, *Remarks on the Sachdev-Ye-Kitaev model*, Phys. Rev. D **94** (2016) 106002.
- [19] E. Witten, *An SYK-like model without disorder*, arXiv:1610.09758 [hep-th]; R. Gurau, *The complete $1/N$ expansion of a SYK-like tensor model*, Nucl. Phys. B **916** (2017) 386.

- [20] J. Ben Geloun and S. Ramgoolam, *Counting tensor model observables and branched covers of the 2-sphere*, Ann. Inst. Henri Poincaré D **1** (2014), 77–138.
- [21] R. Gurau, *Colored group field theory*, Commun. Math. Phys. **304** (2011) 69.
- [22] S. Corley, A. Jevicki, and S. Ramgoolam, *Exact correlators of giant gravitons from dual $N = 4$ SYM theory*, Adv. Theor. Math. Phys. **5** (2002) 809.
- [23] S. Corley and S. Ramgoolam, *Finite factorization equations and sum rules for BPS correlators in $N = 4$ SYM theory*, Nucl. Phys. B **641** (2002) 131.
- [24] T. W. Brown, P. J. Heslop, and S. Ramgoolam, *Diagonal multi-matrix correlators and BPS operators in $N = 4$ SYM*, JHEP **0802** (2008) 030.
- [25] R. de Mello Koch and S. Ramgoolam, *From matrix models and quantum fields to Hurwitz space and the absolute Galois group*, arXiv:1002.1634 [hep-th].
- [26] R. de Mello Koch and S. Ramgoolam, *Strings from Feynman graph counting: without large N* , Phys. Rev. D **85** (2012) 026007.
- [27] R. de Mello Koch and S. Ramgoolam, *A double coset ansatz for integrability in AdS/CFT*, JHEP **1206** (2012) 083.
- [28] R. de Mello Koch, S. Ramgoolam, and C. Wen, *On the refined counting of graphs on surfaces*, Nucl. Phys. B **870** (2013) 530.
- [29] J. Pasukonis and S. Ramgoolam, *Quivers as calculators: Counting, correlators and Riemann surfaces*, JHEP **1304** (2013) 094.
- [30] P. Caputa, R. de Mello Koch, and P. Diaz, *A basis for large operators in $N = 4$ SYM with orthogonal gauge group*, JHEP **1303** (2013) 041.
- [31] P. Mattioli and S. Ramgoolam, *Permutation centralizer algebras and multi-matrix invariants*, Phys. Rev. D **93** (2016), no. 6, 065040.
- [32] P. Diaz and S. J. Rey, *Orthogonal bases of invariants in tensor models*, JHEP **1802** (2018) 089.
- [33] P. Diaz and S. J. Rey, *Invariant operators, orthogonal bases and correlators in general tensor models*, Nucl. Phys. B **932** (2018) 254.

- [34] J. H. Kwak and J. Lee, *Enumeration of graph coverings, surface branched coverings and related group theory*, in: Combinatorial & Computational Mathematics: Present and Future, S. Hong, J. H. Kwak, K. H. Kim, and F. W. Roush (eds.), pp. 97–161, World Scientific, Singapore, (2001).
- [35] J. Ben Geloun and S. Ramgoolam, *Tensor models, Kronecker coefficients and permutation centralizer algebras*, JHEP **1711** (2017) 092.
- [36] H. Itoyama, A. Mironov, and A. Morozov, *Cut and join operator ring in tensor models*, Nucl. Phys. B **932** (2018) 52.
- [37] H. Itoyama, A. Mironov, and A. Morozov, *From Kronecker to tableau pseudo-characters in tensor models*, Phys. Lett. B **788** (2019) 76.
- [38] H. Itoyama and R. Yoshioka, *Generalized cut operation associated with higher order variation in tensor models*, arXiv:1903.10276 [hep-th].
- [39] C. Ikenmeyer, K. D. Mulmuley, and M. Walter, *On vanishing of Kronecker coefficients*, arXiv:1507.02955 [cs.CC].
- [40] J. Blasiak, *Kronecker coefficients for one hook shape*, arXiv:1209.2018 [math.CO].
- [41] S. Carrozza and A. Tanasa, *$O(N)$ random tensor models*, Lett. Math. Phys. **106** (2016), no. 11, 1531.
- [42] R.C. Read, *The enumeration of locally restricted graphs*, Journal London Math. Soc. **34** (1959), 417–436.
- [43] The On-Line Encyclopedia of Integer Sequences, <http://oeis.org>.
- [44] S. Cordes, G. W. Moore, and S. Ramgoolam, *Large N 2-D Yang-Mills theory and topological string theory*, Commun. Math. Phys. **185** (1997) 543.
- [45] S. Cordes, G. W. Moore, and S. Ramgoolam, *Lectures on 2-d Yang-Mills theory, equivariant cohomology and topological field theories*, Nucl. Phys. Proc. Suppl. **41** (1995) 184.
- [46] R. Howe, *Perspectives on invariant theory: Schur duality, multiplicity-free actions and beyond*, in: The Schur Lectures, Israel Mathematical Conference Proceedings, Vol. 8 (1995), pp. 1–182.
- [47] H. Mizukawa, *Wreath product generalization of the triple (S_n, H_n, φ) and their spherical functions*, Journal of Algebra **334** (2011), 31–53.

- [48] I. G. Macdonald, *Symmetric Functions and Hall Polynomials*, 2nd ed., Oxford Univ. Press, (1995).
- [49] V. N. Ivanov, *Bispherical functions on the symmetric group associated with the hyperoctahedral subgroup*, Jour. of Math. Sciences **96** (1999) 3505.
- [50] S. Carrozza and V. Pozsgay, *SYK-like tensor quantum mechanics with $Sp(N)$ symmetry*, Nucl. Phys. B **941** (2019) 28.
- [51] M. R. Bremner, *How to compute the Wedderburn decomposition of a finite-dimensional associative algebra*, Groups, Complexity Cryptology **3** (2011), 47–66.
- [52] M. Hamermesh, *Group Theory and its Application to Physical Problems*, Addison-Wesley, Massachusetts, (1962).

EINSTEIN INSTITUTE OF MATHEMATICS
THE HEBREW UNIVERSITY OF JERUSALEM
GIV'AT RAM, JERUSALEM, 91904, ISRAEL
AND ECOLE NORMALE SUPÉRIEURE, B.P 72, NATITINGOU, BENIN
AND INTERNATIONAL CHAIR IN MATHEMATICAL PHYSICS AND APPLICATIONS
ICMPA-UNESCO CHAIR, 072BP50, COTONOU, BENIN
E-mail address: avohou.r.cocou@mail.huji.ac.il

LIPN, UMR CNRS 7030, INSTITUT GALILÉE
UNIVERSITÉ PARIS 13, SORBONNE PARIS CITÉ
99, AVENUE JEAN-BAPTISTE CLÉMENT, 93430 VILLETANEUSE, FRANCE
AND INTERNATIONAL CHAIR IN MATHEMATICAL PHYSICS AND APPLICATIONS
ICMPA-UNESCO CHAIR, 072BP50, COTONOU, BENIN
E-mail address: bengeloun@lipn.univ-paris13.fr

LIPN, UMR CNRS 7030, INSTITUT GALILÉE
UNIVERSITÉ PARIS 13, SORBONNE PARIS CITÉ
99, AVENUE JEAN-BAPTISTE CLÉMENT, 93430 VILLETANEUSE, FRANCE
E-mail address: dub@lipn.univ-paris13.fr